TERMS AND CONDITIONS

Acknowledgments

It is the purchaser's responsibility to check the acknowledgment document for accuracy, correct fabric and finish selections, etc. on all orders.

Deductions

Deductions from invoices are not allowed for any reason without the company's authorization.

Local Codes

The company considers its product to be office furniture and subject to all applicable local fire, electrical and building codes. SINCE LOCAL CODES VARY, THE PURCHASER IS RESPONSIBLE FOR THE PROPER APPLICATION AND INSTALLATION OF THE COMPANY'S PRODUCT IN ACCORDANCE WITH THE REQUIREMENTS OF THESE LOCAL CODES. Engineering, research and testing have been conducted to have electrical components of the company's products conform to national electrical codes. Only Underwriters Laboratories tested and approved electrical components of the company's products conform to national electrical devices. In addition, some panels and components used by the company have been UL approved. Seller shall not be responsible for any damages or expenses resulting from Purchaser's specifications not conforming to the requirements of the law or local building codes, unless it specifically agrees in writing to do so. Since the company has no control over the use to which others may put its products, each user or specifier should determine the products suitability for the particular application.



Table of Contents

12.2	PANELS	
12.18	DOOR	
12.19	PANEL CONNECTORS	
12.22	ELECTRICAL COMPONENTS	
12.25	WORK SURFACES	
12.30	TABLES	
12.31	OVERHEAD STORAGE	
12.36	PEDESTALS & LATERAL FILES	
12.38	ACCESSORIES	
12.39	MARKERBOARDS	
12.40	FINISHES	

PLACING AN ORDER

How to Place An Order

When ordering, please provide the following information:

1. Purchase order number.
2. "Bill To" and "Ship To" name and address.
(i.e., HENH.6248DT)

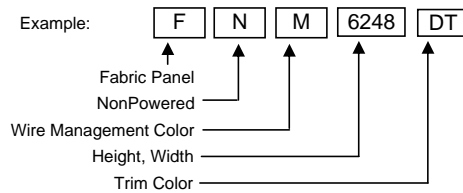

4. Description.
5. Quantity.
6. Project layout.

AO2 NONPOWERED FABRIC PANEL

Product Description

Fabric covered hard surface panel with nonpowered wire management unit attached. Includes (1) panel, (2) base covers & (1) metal base attached.

PANEL CONNECTORS MUST BE ORDERED SEPARATELY.

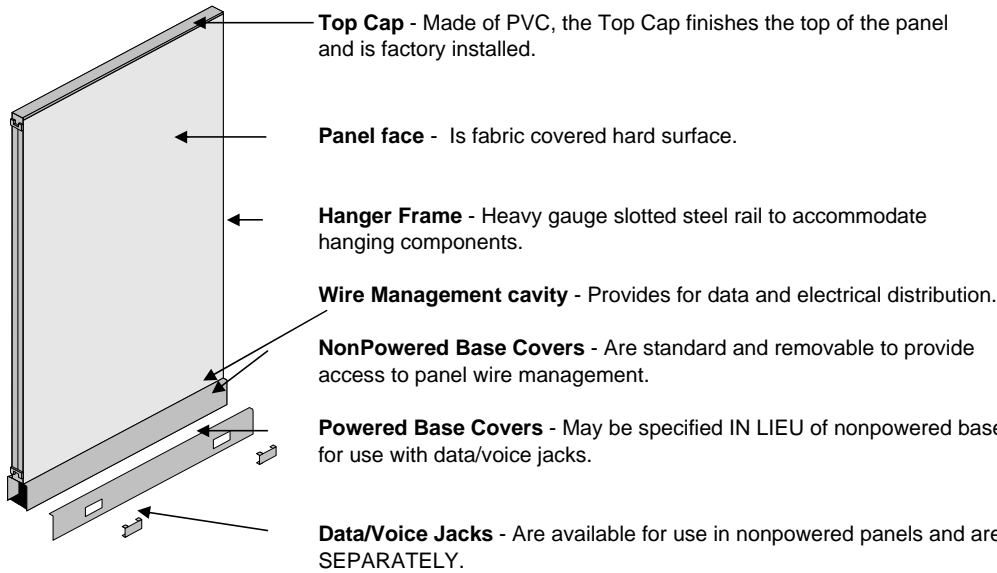

Actual Dimensions

Depth (Thickness)	2" at top, 3 3/8" at base
Width	12", 18", 24", 30", 36", 42", 48" & 60"
Height (Minimum)	39", 47", 53", 62", 67" & 85"
Wire Management	5"

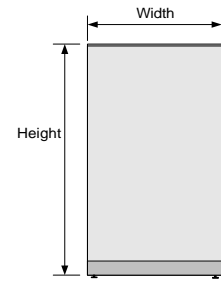

Specify:

- * Product number.
- * Wire Management color – "Y" (D=DT, M=MT)
- * Trim color – "XX" (DT, LG, MT)

Note:

- * Order Finished End (Pg. 9.20) to finish exposed panel end.
- * Order Panel Connectors (Pgs. 9.19 - 9.20) separately.
- * Fabric yardage estimate is for directional application (minimum 66" usable width).
- * Special fabrics may affect yardage requirements.

Model Number	Dimension H x W	COM	Fabric			Weight
			Grade A	Grade B	Grade C	
FPNY.3912XX	39 x 12	\$ 317	\$ 351	\$ 386	\$ 420	16
FPNY.3918XX	39 x 18	\$ 336	\$ 370	\$ 404	\$ 439	21
FPNY.3924XX	39 x 24	\$ 344	\$ 378	\$ 412	\$ 447	22
FPNY.3930XX	39 x 30	\$ 381	\$ 414	\$ 476	\$ 538	23
FPNY.3936XX	39 x 36	\$ 436	\$ 468	\$ 529	\$ 592	28
FPNY.3942XX	39 x 42	\$ 464	\$ 494	\$ 556	\$ 618	31
FPNY.3948XX	39 x 48	\$ 488	\$ 518	\$ 581	\$ 643	33
FPNY.3960XX	39 x 60	\$ 618	\$ 645	\$ 708	\$ 769	39

AO2 NONPOWERED FABRIC PANEL**Specify:**

- * Product number.
- * Wire Management color – “Y” (D=DT, M=MT)
- * Trim color – “XX” (DT, LG, MT)

Note:

- * Order Finished End (Pg. 9.20) to finish exposed panel end.
- * Order Panel Connectors (Pgs. 9.19 - 9.20) separately.
- * Fabric yardage estimate is for directional application (minimum 66" usable width).
- * Special fabrics may affect yardage requirements.



Model Number	Dimension H x W	COM	Fabric			Weight	
			Grade A	Grade B	Grade C		
FPNY.4712XX	47 x 12	\$	328 \$	373 \$	390 \$	447	20
FPNY.4718XX	47 x 18	\$	346 \$	390 \$	447 \$	465	24
FPNY.4724XX	47 x 24	\$	381 \$	427 \$	457 \$	475	25
FPNY.4730XX	47 x 30	\$	437 \$	480 \$	559 \$	596	28
FPNY.4736XX	47 x 36	\$	504 \$	546 \$	642 \$	661	32
FPNY.4742XX	47 x 42	\$	531 \$	572 \$	683 \$	719	34
FPNY.4748XX	47 x 48	\$	548 \$	587 \$	727 \$	734	37
FPNY.4760XX	47 x 60	\$	689 \$	725 \$	889 \$	872	42
FPNY.5312XX	53 x 12	\$	338 \$	382 \$	391 \$	465	22
FPNY.5318XX	53 x 18	\$	346 \$	402 \$	452 \$	484	26
FPNY.5324XX	53 x 24	\$	376 \$	410 \$	461 \$	492	27
FPNY.5330XX	53 x 30	\$	434 \$	467 \$	569 \$	632	31
FPNY.5336XX	53 x 36	\$	507 \$	557 \$	651 \$	723	36
FPNY.5342XX	53 x 42	\$	540 \$	590 \$	691 \$	756	40
FPNY.5348XX	53 x 48	\$	581 \$	630 \$	735 \$	796	43
FPNY.5360XX	53 x 60	\$	731 \$	777 \$	897 \$	942	50
FPNY.6212XX	62 x 12	\$	351 \$	376 \$	423 \$	486	24
FPNY.6218XX	62 x 18	\$	411 \$	465 \$	512 \$	575	30
FPNY.6224XX	62 x 24	\$	453 \$	495 \$	520 \$	585	32
FPNY.6230XX	62 x 30	\$	482 \$	534 \$	649 \$	735	35
FPNY.6236XX	62 x 36	\$	469 \$	618 \$	745 \$	820	41
FPNY.6242XX	62 x 42	\$	612 \$	660 \$	790 \$	862	45
FPNY.6248XX	62 x 48	\$	658 \$	706 \$	838 \$	907	50
FPNY.6260XX	62 x 60	\$	828 \$	871 \$	960 \$	1,073	59
FPNY.6712XX	67 x 12	\$	353 \$	408 \$	462 \$	518	24
FPNY.6718XX	67 x 18	\$	416 \$	470 \$	525 \$	580	30
FPNY.6724XX	67 x 24	\$	457 \$	500 \$	535 \$	590	32
FPNY.6730XX	67 x 30	\$	487 \$	539 \$	644 \$	747	35
FPNY.6736XX	67 x 36	\$	574 \$	623 \$	728 \$	832	41
FPNY.6742XX	67 x 42	\$	616 \$	664 \$	769 \$	873	45
FPNY.6748XX	67 x 48	\$	662 \$	710 \$	815 \$	919	50
FPNY.6760XX	67 x 60	\$	832 \$	876 \$	981 \$	1,085	59
FPNY.8512XX	85 x 12	\$	376 \$	469 \$	535 \$	602	34
FPNY.8518XX	85 x 18	\$	469 \$	559 \$	626 \$	692	42
FPNY.8524XX	85 x 24	\$	477 \$	568 \$	634 \$	700	44
FPNY.8530XX	85 x 30	\$	542 \$	631 \$	764 \$	896	50
FPNY.8536XX	85 x 36	\$	643 \$	729 \$	862 \$	995	55
FPNY.8542XX	85 x 42	\$	690 \$	776 \$	908 \$	1,041	60
FPNY.8548XX	85 x 48	\$	742 \$	826 \$	958 \$	1,091	64
FPNY.8560XX	85 x 60	\$	869 \$	951 \$	1,083 \$	1,215	74

AO2 POWERED FABRIC PANEL

Product Description

Fabric covered hard surface panel with powered wire management unit attached. Includes (1) panel, (2) base covers, (1) metal base attached & (1) electrical harness. Duplex receptacles must be ordered separately.

PANEL CONNECTORS MUST BE ORDERED SEPARATELY.

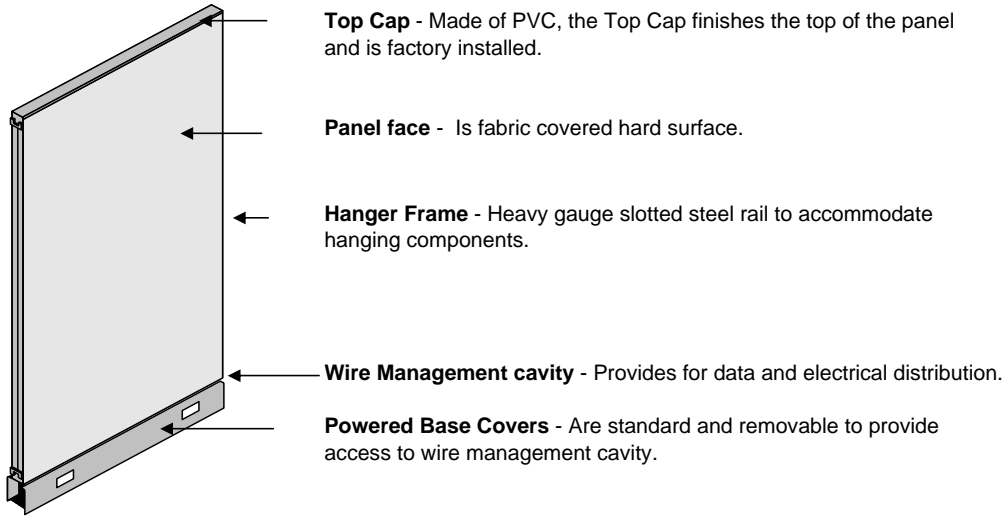

Actual Dimensions

Depth (Thickness)	2" at top, 3 3/8" at base
Width	24", 30", 36", 42", 48" & 60"
Height (Minimum)	39", 47", 53", 67" & 85"
Wire Management	5"

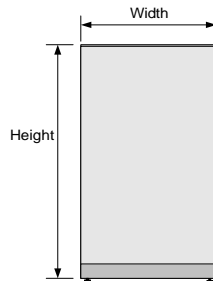

AO2 POWERED FABRIC PANEL**Specify:**

- * Product number.
- * Wire Management color – “Y” (D=DT, M=MT)
- * Trim color – “XX” (DT, LG, MT)

Note:

- * Includes Electrical Harness.
- * Order Finished End (Pg. 9.20) to finish exposed panel end.
- * Order Panel Connectors (Pgs. 9.19 - 9.20) and Festoons (Pg. 9.22) separately.
- * Fabric yardage estimate is for directional application (minimum 66" usable width).
- * Special fabrics may affect yardage requirements.



Model Number	Dimension H x W	COM	Fabric			Weight
			Grade A	Grade B	Grade C	
FPPY.3924XX	39 x 24	\$ 518	\$ 536	\$ 570	\$ 605	25
FPPY.3930XX	39 x 30	\$ 556	\$ 572	\$ 633	\$ 695	26
FPPY.3936XX	39 x 36	\$ 611	\$ 624	\$ 686	\$ 748	31
FPPY.3942XX	39 x 42	\$ 640	\$ 651	\$ 714	\$ 776	34
FPPY.3948XX	39 x 48	\$ 667	\$ 677	\$ 739	\$ 801	36
FPPY.3960XX	39 x 60	\$ 797	\$ 801	\$ 863	\$ 926	42
FPPY.4724XX	47 x 24	\$ 531	\$ 558	\$ 595	\$ 632	28
FPPY.4730XX	47 x 30	\$ 581	\$ 606	\$ 680	\$ 753	31
FPPY.4736XX	47 x 36	\$ 649	\$ 671	\$ 744	\$ 818	35
FPPY.4742XX	47 x 42	\$ 709	\$ 727	\$ 801	\$ 874	37
FPPY.4748XX	47 x 48	\$ 727	\$ 746	\$ 819	\$ 893	40
FPPY.4760XX	47 x 60	\$ 873	\$ 884	\$ 957	\$ 1,031	45
FPPY.5324XX	53 x 24	\$ 551	\$ 567	\$ 609	\$ 650	30
FPPY.5330XX	53 x 30	\$ 588	\$ 623	\$ 706	\$ 789	34
FPPY.5336XX	53 x 36	\$ 674	\$ 705	\$ 787	\$ 869	39
FPPY.5342XX	53 x 42	\$ 719	\$ 748	\$ 830	\$ 914	43
FPPY.5348XX	53 x 48	\$ 761	\$ 788	\$ 870	\$ 953	46
FPPY.5360XX	53 x 60	\$ 914	\$ 933	\$ 1,017	\$ 1,099	53
FPPY.6224XX	62 x 24	\$ 577	\$ 613	\$ 667	\$ 723	35
FPPY.6230XX	62 x 30	\$ 632	\$ 665	\$ 766	\$ 867	38
FPPY.6236XX	62 x 36	\$ 721	\$ 750	\$ 851	\$ 952	44
FPPY.6242XX	62 x 42	\$ 783	\$ 809	\$ 911	\$ 1,011	48
FPPY.6248XX	62 x 48	\$ 821	\$ 845	\$ 946	\$ 1,048	53
FPPY.6260XX	62 x 60	\$ 987	\$ 1,003	\$ 1,104	\$ 1,205	62
FPPY.6724XX	67 x 24	\$ 602	\$ 636	\$ 691	\$ 746	35
FPPY.6730XX	67 x 30	\$ 662	\$ 693	\$ 798	\$ 903	38
FPPY.6736XX	67 x 36	\$ 753	\$ 780	\$ 885	\$ 990	44
FPPY.6742XX	67 x 42	\$ 797	\$ 822	\$ 927	\$ 1,032	48
FPPY.6748XX	67 x 48	\$ 843	\$ 866	\$ 970	\$ 1,075	53
FPPY.6760XX	67 x 60	\$ 1,020	\$ 1,033	\$ 1,138	\$ 1,243	62
FPPY.8524XX	85 x 24	\$ 653	\$ 724	\$ 790	\$ 957	47
FPPY.8530XX	85 x 30	\$ 720	\$ 788	\$ 920	\$ 1,053	53
FPPY.8536XX	85 x 36	\$ 784	\$ 824	\$ 1,020	\$ 1,152	58
FPPY.8542XX	85 x 42	\$ 873	\$ 933	\$ 1,066	\$ 1,198	63
FPPY.8548XX	85 x 48	\$ 925	\$ 983	\$ 1,115	\$ 1,248	67
FPPY.8560XX	85 x 60	\$ 1,057	\$ 1,108	\$ 1,241	\$ 1,374	77

AO2 NONPOWERED FABRIC ACOUSTICAL PANEL

Product Description

Fabric covered sound-reducing panel with nonpowered wire management unit attached. Includes (1) panel, (2) base covers, & (1) metal base attached. NRC rating .60 - STC rating 24.

PANEL CONNECTORS MUST BE ORDERED SEPARATELY.

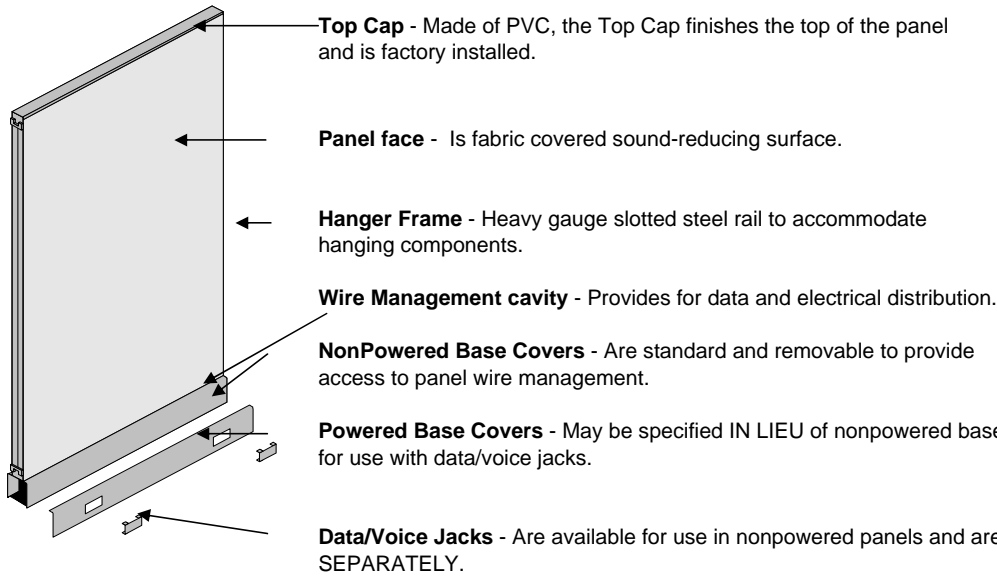

Actual Dimensions

Depth (Thickness)	2" at top, 3 3/8" at base
Width	12", 18", 24", 30", 36", 42", 48" & 60"
Height (Minimum)	39", 47", 53", 62", 67" & 85"
Wire Management	5"

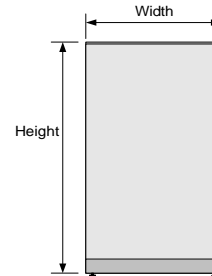

Specify:

- * Product number.
- * Wire Management color – "Y" (D=DT, M=MT)
- * Trim color – "XX" (DT, LG, MT)

Note:

- * Order Finished End (Pg. 9.20) to finish exposed panel end.
- * Order Panel Connectors (Pgs. 9.19 - 9.20) separately.
- * Fabric yardage estimate is for directional application (minimum 66" usable width).

AO2 NONPOWERED FABRIC ACOUSTICAL PANEL**Specify:**

- * Product number.
- * Wire Management color – “Y” (D=DT, M=MT)
- * Trim color – “XX” (DT, LG, MT)

Note:

- * Order Finished End (Pg. 9.20) to finish exposed panel end.
- * Order Panel Connectors (Pgs. 9.19 - 9.20) separately.
- * Fabric yardage estimate is for directional application (minimum 66" usable width).
- * Special fabrics may affect yardage requirements.



Model Number	Dimension H x W	COM	Fabric			Weight	
			Grade A	Grade B	Grade C		
FAPNY.5312XX	53 x 12	\$	448 \$	492 \$	534 \$	575	25
FAPNY.5318XX	53 x 18	\$	507 \$	548 \$	589 \$	630	29
FAPNY.5324XX	53 x 24	\$	514 \$	555 \$	596 \$	639	30
FAPNY.5330XX	53 x 30	\$	567 \$	605 \$	688 \$	770	34
FAPNY.5336XX	53 x 36	\$	641 \$	676 \$	758 \$	842	39
FAPNY.5342XX	53 x 42	\$	677 \$	711 \$	793 \$	877	43
FAPNY.5348XX	53 x 48	\$	716 \$	749 \$	831 \$	915	46
FAPNY.5360XX	53 x 60	\$	893 \$	918 \$	1,000 \$	1,084	53
FAPNY.6212XX	62 x 12	\$	474 \$	516 \$	571 \$	626	27
FAPNY.6218XX	62 x 18	\$	519 \$	559 \$	615 \$	670	33
FAPNY.6224XX	62 x 24	\$	529 \$	571 \$	625 \$	681	35
FAPNY.6230XX	62 x 30	\$	576 \$	615 \$	716 \$	817	38
FAPNY.6236XX	62 x 36	\$	662 \$	697 \$	798 \$	899	44
FAPNY.6242XX	62 x 42	\$	693 \$	726 \$	828 \$	929	48
FAPNY.6248XX	62 x 48	\$	734 \$	765 \$	867 \$	968	53
FAPNY.6260XX	62 x 60	\$	905 \$	929 \$	1,030 \$	1,132	62
FAPNY.6712XX	67 x 12	\$	483 \$	525 \$	581 \$	637	27
FAPNY.6718XX	67 x 18	\$	529 \$	571 \$	625 \$	681	33
FAPNY.6724XX	67 x 24	\$	540 \$	580 \$	635 \$	690	35
FAPNY.6730XX	67 x 30	\$	592 \$	630 \$	735 \$	840	38
FAPNY.6736XX	67 x 36	\$	672 \$	706 \$	810 \$	915	44
FAPNY.6742XX	67 x 42	\$	703 \$	735 \$	841 \$	946	48
FAPNY.6748XX	67 x 48	\$	750 \$	780 \$	885 \$	990	53
FAPNY.6760XX	67 x 60	\$	916 \$	939 \$	1,045 \$	1,149	62
FAPNY.8512XX	85 x 12	\$	526 \$	606 \$	672 \$	739	37
FAPNY.8518XX	85 x 18	\$	587 \$	664 \$	730 \$	796	45
FAPNY.8524XX	85 x 24	\$	591 \$	671 \$	737 \$	803	47
FAPNY.8530XX	85 x 30	\$	650 \$	724 \$	857 \$	989	53
FAPNY.8536XX	85 x 36	\$	751 \$	820 \$	953 \$	1,086	58
FAPNY.8542XX	85 x 42	\$	796 \$	863 \$	996 \$	1,129	63
FAPNY.8548XX	85 x 48	\$	857 \$	922 \$	1,054 \$	1,187	67
FAPNY.8560XX	85 x 60	\$	992 \$	1,052 \$	1,184 \$	1,316	77

AO2 POWERED FABRIC ACOUSTICAL PANEL

Product Description

Fabric covered sound-reducing panel with powered wire management unit attached. Includes (1) panel, (2) base covers, (1) metal base attached & (1) electrical harness. Duplex receptacles must be ordered separately. NRC rating .60 - STC rating 24.

PANEL CONNECTORS MUST BE ORDERED SEPARATELY.

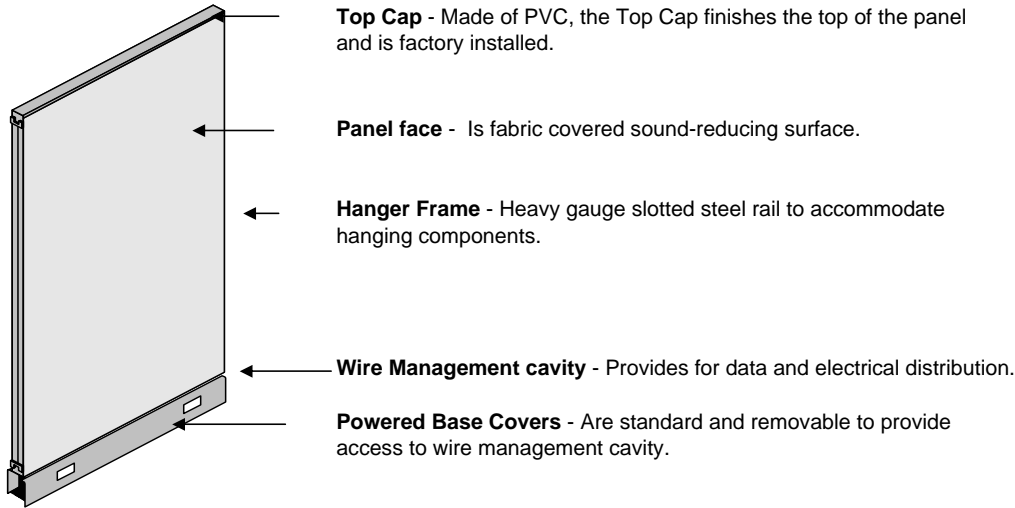

Actual Dimensions

Depth (Thickness)	2" at top, 3 3/8" at base
Width	24", 30", 36", 42", 48" & 60"
Height (Minimum)	39", 47", 53", 62", 67" & 85"
Wire Management	5"

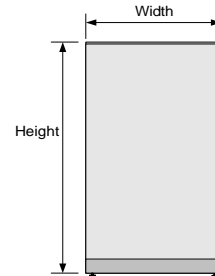

A02 POWERED FABRIC ACOUSTICAL PANEL**Specify:**

- * Product number.
- * Wire Management color – “Y” (D=DT, M=MT)
- * Trim color – “XX” (DT, LG, MT)

Note:

- * Includes Electrical Harness.
- * Order Finished End (Pg. 9.20) to finish exposed panel end.
- * Order Panel Connectors (Pgs. 9.19 - 9.20) and Festoons (Pg. 9.22) separately.
- * Fabric yardage estimate is for directional application (minimum 66" usable width).
- * Special fabrics may affect yardage requirements.



Model Number	Dimension H x W	COM	Fabric			Weight
			Grade A	Grade B	Grade C	
FAPPY.5324XX	53 x 24	\$ 667	\$ 714	\$ 755	\$ 796	33
FAPPY.5330XX	53 x 30	\$ 715	\$ 761	\$ 844	\$ 927	37
FAPPY.5336XX	53 x 36	\$ 788	\$ 832	\$ 915	\$ 998	42
FAPPY.5342XX	53 x 42	\$ 825	\$ 868	\$ 951	\$ 1,033	46
FAPPY.5348XX	53 x 48	\$ 863	\$ 905	\$ 989	\$ 1,071	49
FAPPY.5360XX	53 x 60	\$ 1,038	\$ 1,075	\$ 1,159	\$ 1,241	56
FAPPY.6224XX	62 x 24	\$ 684	\$ 730	\$ 786	\$ 842	38
FAPPY.6230XX	62 x 30	\$ 735	\$ 782	\$ 883	\$ 984	41
FAPPY.6236XX	62 x 36	\$ 812	\$ 855	\$ 957	\$ 1,058	47
FAPPY.6242XX	62 x 42	\$ 844	\$ 887	\$ 988	\$ 1,090	51
FAPPY.6248XX	62 x 48	\$ 893	\$ 934	\$ 1,035	\$ 1,137	56
FAPPY.6260XX	62 x 60	\$ 1,050	\$ 1,088	\$ 1,189	\$ 1,290	65
FAPPY.6724XX	67 x 24	\$ 690	\$ 736	\$ 792	\$ 848	38
FAPPY.6730XX	67 x 30	\$ 742	\$ 787	\$ 891	\$ 996	41
FAPPY.6736XX	67 x 36	\$ 818	\$ 861	\$ 966	\$ 1,071	47
FAPPY.6742XX	67 x 42	\$ 852	\$ 894	\$ 999	\$ 1,104	51
FAPPY.6748XX	67 x 48	\$ 896	\$ 937	\$ 1,042	\$ 1,147	56
FAPPY.6760XX	67 x 60	\$ 1,060	\$ 1,097	\$ 1,202	\$ 1,307	65
FAPPY.8524XX	85 x 24	\$ 744	\$ 828	\$ 894	\$ 960	50
FAPPY.8530XX	85 x 30	\$ 798	\$ 882	\$ 1,015	\$ 1,146	56
FAPPY.8536XX	85 x 36	\$ 900	\$ 981	\$ 1,113	\$ 1,246	61
FAPPY.8542XX	85 x 42	\$ 941	\$ 1,021	\$ 1,154	\$ 1,285	66
FAPPY.8548XX	85 x 48	\$ 1,000	\$ 1,078	\$ 1,210	\$ 1,343	70
FAPPY.8560XX	85 x 60	\$ 1,124	\$ 1,198	\$ 1,331	\$ 1,464	80

AO2 NONPOWERED FABRIC TACKABLE ACOUSTICAL PANEL

Product Description

Fabric covered tackable sound-reducing panel with nonpowered wire management unit attached. Includes (1) panel, (2) base covers & (1) metal base attached. NRC rating .48 - STC rating 27.

PANEL CONNECTORS MUST BE ORDERED SEPARATELY.

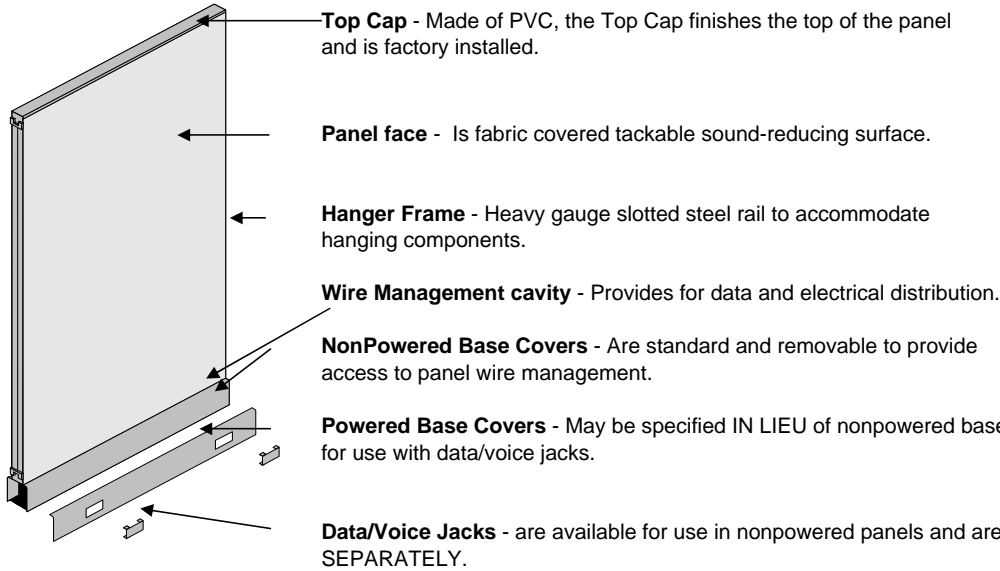

Actual Dimensions

Depth (Thickness)	2" at top, 3 3/8" at base
Width	12", 18", 24", 30", 36", 42", 48" & 60"
Height (Minimum)	39", 47", 53", 62", 67" & 85"
Wire Management	5"

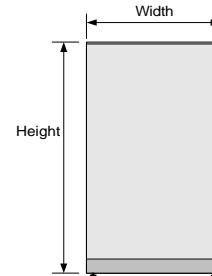

Specify:

- * Product number.
- * Wire Management color – "Y" (D=DT, M=MT)
- * Trim color – "XX" (DT, LG, MT)

Note:

- * Order Finished End (Pg. 9.20) to finish exposed panel end.
- * Order Panel Connectors (Pgs. 9.19 - 9.20) separately.
- * Fabric yardage estimate is for directional application (minimum 66" usable width).
- * Special fabrics may affect yardage requirements.

AO2 NONPOWERED FABRIC TACKABLE ACOUSTICAL PANEL**Specify:**

- * Product number.
- * Wire Management color – “Y” (D=DT, M=MT)
- * Trim color – “XX” (DT, LG, MT)

Note:

- * Order Finished End (Pg. 9.20) to finish exposed panel end.
- * Order Panel Connectors (Pgs. 9.19 - 9.20) separately.
- * Fabric yardage estimate is for directional application (minimum 66" usable width).
- * Special fabrics may affect yardage requirements.



Model Number	Dimension H x W	COM	Fabric			Weight	
			Grade A	Grade B	Grade C		
FTPNY.5312XX	53 x 12	\$	456 \$	481 \$	526 \$	564	31
FTPNY.5318XX	53 x 18	\$	492 \$	519 \$	561 \$	603	35
FTPNY.5324XX	53 x 24	\$	506 \$	560 \$	602 \$	644	36
FTPNY.5330XX	53 x 30	\$	539 \$	607 \$	690 \$	773	40
FTPNY.5336XX	53 x 36	\$	562 \$	645 \$	728 \$	811	45
FTPNY.5342XX	53 x 42	\$	584 \$	681 \$	764 \$	847	49
FTPNY.5348XX	53 x 48	\$	621 \$	732 \$	816 \$	898	52
FTPNY.5360XX	53 x 60	\$	682 \$	822 \$	905 \$	988	59
FTPNY.6212XX	62 x 12	\$	492 \$	516 \$	572 \$	626	33
FTPNY.6218XX	62 x 18	\$	520 \$	558 \$	614 \$	668	39
FTPNY.6224XX	62 x 24	\$	550 \$	603 \$	658 \$	713	41
FTPNY.6230XX	62 x 30	\$	586 \$	652 \$	754 \$	855	44
FTPNY.6236XX	62 x 36	\$	614 \$	694 \$	796 \$	897	49
FTPNY.6242XX	62 x 42	\$	641 \$	736 \$	838 \$	939	54
FTPNY.6248XX	62 x 48	\$	682 \$	792 \$	893 \$	994	60
FTPNY.6260XX	62 x 60	\$	751 \$	888 \$	989 \$	1,091	70
FTPNY.6712XX	67 x 12	\$	476 \$	516 \$	572 \$	626	34
FTPNY.6718XX	67 x 18	\$	520 \$	558 \$	614 \$	668	40
FTPNY.6724XX	67 x 24	\$	567 \$	603 \$	658 \$	713	42
FTPNY.6730XX	67 x 30	\$	619 \$	652 \$	757 \$	862	45
FTPNY.6736XX	67 x 36	\$	663 \$	694 \$	799 \$	904	50
FTPNY.6742XX	67 x 42	\$	708 \$	736 \$	842 \$	947	55
FTPNY.6748XX	67 x 48	\$	765 \$	792 \$	897 \$	1,001	61
FTPNY.6760XX	67 x 60	\$	885 \$	888 \$	993 \$	1,098	71
FTPNY.8512XX	85 x 12	\$	539 \$	625 \$	691 \$	757	45
FTPNY.8518XX	85 x 18	\$	608 \$	656 \$	722 \$	788	53
FTPNY.8524XX	85 x 24	\$	656 \$	689 \$	756 \$	822	55
FTPNY.8530XX	85 x 30	\$	751 \$	840 \$	973 \$	1,105	61
FTPNY.8536XX	85 x 36	\$	785 \$	872 \$	1,004 \$	1,137	66
FTPNY.8542XX	85 x 42	\$	814 \$	900 \$	1,033 \$	1,166	72
FTPNY.8548XX	85 x 48	\$	863 \$	947 \$	1,079 \$	1,212	76
FTPNY.8560XX	85 x 60	\$	938 \$	1,019 \$	1,152 \$	1,283	85

AO2 POWERED FABRIC TACKABLE ACOUSTICAL PANEL

Product Description

Fabric covered tackable sound-reducing panel with nonpowered wire management unit attached. Includes (1) panel, (2) base covers & (1) metal base attached. NRC rating .48 - STC rating 27.
 NRC rating .48 - STC rating 27.



PANEL CONNECTORS MUST BE ORDERED SEPARATELY.

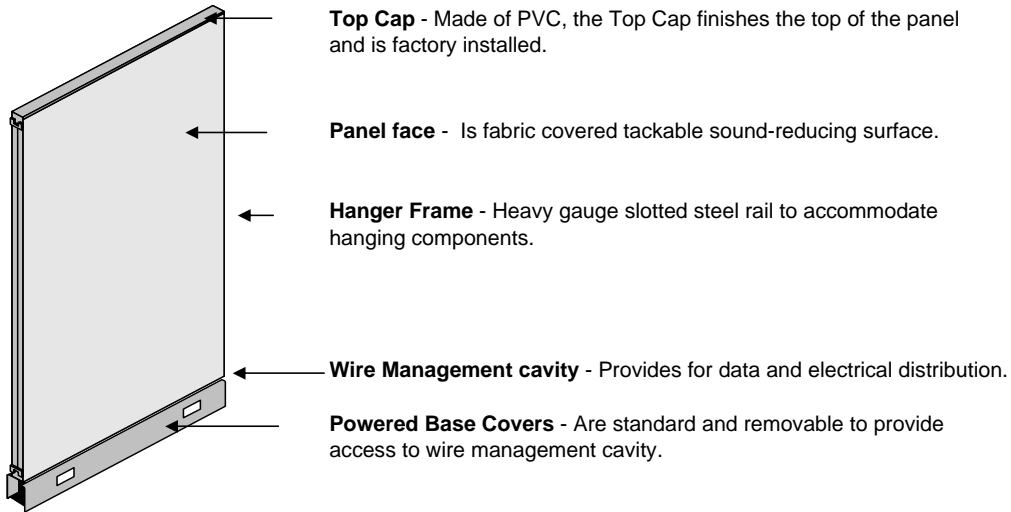

Actual Dimensions

Depth (Thickness)	2" at top, 3 3/8" at base
Width	24", 30", 36", 42", 48" & 60"
Height (Minimum)	39", 47", 53", 62", 67" & 85"
Wire Management	5"

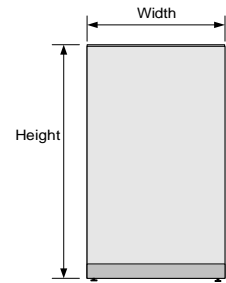

AO2 POWERED FABRIC TACKABLE ACOUSTICAL PANEL

Specify:

- * Product number.
- * Wire Management color – “Y” (D=DT, M=MT)
- * Trim color – “XX” (DT, LG, MT)

Note:

- * Includes Electrical Harness.
- * Order Finished End (Pg. 9.20) to finish exposed panel end.
- * Order Panel Connectors (Pgs. 9.19 - 9.20) and Festoons (Pg. 9.22) separately.
- * Fabric yardage estimate is for directional application (minimum 66" usable width).
- * Special fabrics may affect yardage requirements.



Model Number	Dimension H x W	COM	Fabric			Weight
			Grade A	Grade B	Grade C	
FTPPY.5324XX	53 x 24	\$ 603	\$ 667	\$ 708	\$ 749	40
FTPPY.5330XX	53 x 30	\$ 638	\$ 717	\$ 799	\$ 883	44
FTPPY.5336XX	53 x 36	\$ 667	\$ 760	\$ 843	\$ 926	49
FTPPY.5342XX	53 x 42	\$ 692	\$ 802	\$ 885	\$ 968	53
FTPPY.5348XX	53 x 48	\$ 733	\$ 857	\$ 940	\$ 1,023	56
FTPPY.5360XX	53 x 60	\$ 802	\$ 956	\$ 1,038	\$ 1,121	63
		\$ -	\$ -			
FTPPY.6224XX	62 x 24	\$ 632	\$ 695	\$ 751	\$ 806	42
FTPPY.6230XX	62 x 30	\$ 668	\$ 748	\$ 849	\$ 950	45
FTPPY.6236XX	62 x 36	\$ 709	\$ 793	\$ 894	\$ 995	50
FTPPY.6242XX	62 x 42	\$ 816	\$ 839	\$ 940	\$ 1,042	60
FTPPY.6248XX	62 x 48	\$ 852	\$ 896	\$ 998	\$ 1,099	64
FTPPY.6260XX	62 x 60	\$ 952	\$ 999	\$ 1,100	\$ 1,201	74
		\$ -	\$ -			
FTPPY.6724XX	67 x 24	\$ 643	\$ 707	\$ 761	\$ 817	43
FTPPY.6730XX	67 x 30	\$ 679	\$ 760	\$ 865	\$ 970	46
FTPPY.6736XX	67 x 36	\$ 719	\$ 808	\$ 913	\$ 1,018	51
FTPPY.6742XX	67 x 42	\$ 826	\$ 855	\$ 960	\$ 1,065	61
FTPPY.6742XX	67 x 48	\$ 965	\$ 1,017	\$ 1,018	\$ 1,123	65
FTPPY.6760XX	67 x 60	\$ 1,025	\$ 1,111	\$ 1,124	\$ 1,229	75
		\$ -	\$ -			
FTPPY.8524XX	85 x 24	\$ 695	\$ 791	\$ 857	\$ 923	59
FTPPY.8530XX	85 x 30	\$ 764	\$ 946	\$ 1,078	\$ 1,211	64
FTPPY.8536XX	85 x 36	\$ 846	\$ 982	\$ 1,114	\$ 1,247	70
FTPPY.8542XX	85 x 42	\$ 903	\$ 1,016	\$ 1,148	\$ 1,280	76
FTPPY.8548XX	85 x 48	\$ 951	\$ 1,066	\$ 1,199	\$ 1,332	80
FTPPY.8560XX	85 x 60	\$ 1,093	\$ 1,145	\$ 1,278	\$ 1,410	89

AO2 NONPOWERED FABRIC HALF GLAZED PANEL



Product Description

Upper section glazed , lower section fabric covered hard surface panel with nonpowered wire management unit attached. Includes (1) panel, (2) base covers, (1) metal base attached & (1) electrical harness. Duplex receptacles must be ordered separately. NOTE : HALF GLAZED FABRIC PANEL WITH YOUR CHOICE OF BRONZE OR CLEAR GLAZING

PANEL CONNECTORS MUST BE ORDERED SEPARATELY.

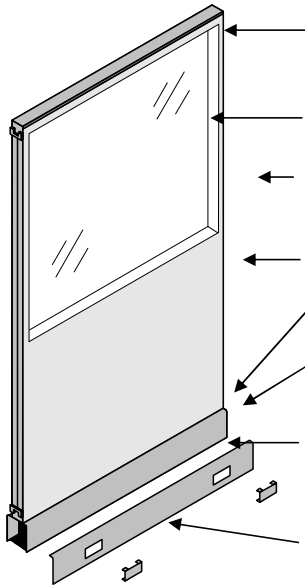

Top Cap - Made of PVC, the Top Cap finishes the top of the panel and is factory installed.

Glazed face - Is translucent acrylic insert.

Hanger Frame - Heavy gauge slotted steel rail to accommodate hanging components.

Panel face - Is fabric covered hard surface.

Wire Management cavity - Provides for data and electrical distribution.

NonPowered Base Covers - Are standard and removable to provide access to panel wire management.

Powered Base Covers - May be specified IN LIEU of nonpowered base covers for use with data/voice jacks.

Data/Voice Jacks - are available for use in nonpowered panels and are specified SEPARATELY.

Actual Dimensions

Depth (Thickness)	2" at top, 3 3/8" at base
Width	24", 30", 36", 42", 48" & 60"
Height (Minimum)	62", 67" & 85"
Wire Management	5"

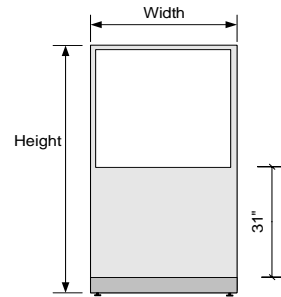

AO2 NONPOWERED FABRIC HALF GLAZED PANEL

**Specify:**

- * Product number.
- * Wire Management color – "Y" (D=DT, M=MT)
- * Trim color – "YX" (DT, LG, MT)
- * Glazing color (BR or CL).
- * Fabric name and style number.

Note:

- * Order Finished End (Pg. 9.20) to finish exposed panel end.
- * Order Panel Connectors (Pgs. 9.19 - 9.20) separately.
- * Fabric yardage estimate is for directional application (minimum 66" usable width).
- * Special fabrics may affect yardage requirements.

Model Number	Dimension H x W	COM	Fabric			Weight
			Grade A	Grade B	Grade C	
PANEL WITH BRONZE GLAZING						
HGGBRNY.6224XX	62 x 24	\$	1,209	\$ 1,272	\$ 1,328	37
HGGBRNY.6230XX	62 x 30	\$	1,563	\$ 1,626	\$ 1,727	40
HGGBRNY.6236XX	62 x 36	\$	1,621	\$ 1,684	\$ 1,785	46
HGGBRNY.6242XX	62 x 42	\$	1,858	\$ 1,922	\$ 2,023	50
HGGBRNY.6248XX	62 x 48	\$	1,906	\$ 1,969	\$ 2,070	55
HGGBRNY.6724XX	67 x 24	\$	1,394	\$ 1,457	\$ 1,512	38
HGGBRNY.6730XX	67 x 30	\$	1,605	\$ 1,669	\$ 1,773	41
HGGBRNY.6736XX	67 x 36	\$	1,668	\$ 1,731	\$ 1,836	47
HGGBRNY.6742XX	67 x 42	\$	1,900	\$ 1,964	\$ 2,068	51
HGGBRNY.6748XX	67 x 48	\$	1,953	\$ 2,017	\$ 21,212	56
HGGBRNY.8524XX	85 x 24	\$	1,578	\$ 1,642	\$ 1,708	49
HGGBRNY.8530XX	85 x 30	\$	1,826	\$ 1,890	\$ 2,022	55
HGGBRNY.8536XX	85 x 36	\$	1,910	\$ 1,973	\$ 2,105	60
HGGBRNY.8542XX	85 x 42	\$	2,037	\$ 2,100	\$ 2,232	65
HGGBRNY.8548XX	85 x 48	\$	2,228	\$ 2,291	\$ 2,424	69
PANEL WITH CLEAR GLAZING						
HGGCLNY.6224XX	62 x 24	\$	1,209	\$ 1,272	\$ 1,328	37
HGGCLNY.6230XX	62 x 30	\$	1,563	\$ 1,626	\$ 1,727	40
HGGCLNY.6236XX	62 x 36	\$	1,621	\$ 1,684	\$ 1,785	46
HGGCLNY.6242XX	62 x 42	\$	1,858	\$ 1,922	\$ 2,023	50
HGGCLNY.6248XX	62 x 48	\$	1,906	\$ 1,969	\$ 2,070	55
HGGCLNY.6724XX	67 x 24	\$	1,394	\$ 1,457	\$ 1,512	38
HGGCLNY.6730XX	67 x 30	\$	1,605	\$ 1,669	\$ 1,773	41
HGGCLNY.6736XX	67 x 36	\$	1,668	\$ 1,731	\$ 1,836	47
HGGCLNY.6742XX	67 x 42	\$	1,900	\$ 1,964	\$ 2,068	51
HGGCLNY.6748XX	67 x 48	\$	1,953	\$ 2,017	\$ 21,212	56
HGGCLNY.8524XX	85 x 24	\$	1,578	\$ 1,642	\$ 1,708	49
HGGCLNY.8530XX	85 x 30	\$	1,826	\$ 1,890	\$ 2,022	55
HGGCLNY.8536XX	85 x 36	\$	1,910	\$ 1,973	\$ 2,105	60
HGGCLNY.8542XX	85 x 42	\$	2,037	\$ 2,100	\$ 2,232	65
HGGCLNY.8548XX	85 x 48	\$	2,228	\$ 2,291	\$ 2,424	69

AO2 POWERED FABRIC HALF GLAZED PANEL



Product Description

Upper section glazed , lower section fabric covered hard surface panel with nonpowered wire management unit attached. Includes (1) panel, (2) base covers, (1) metal base attached & (1) electrical harness. Duplex receptacles must be ordered separately. NOTE : HALF GLAZED FABRIC PANEL WITH YOUR CHOICE OF BRONZE OR CLEAR GLAZING

PANEL CONNECTORS MUST BE ORDERED SEPARATELY.

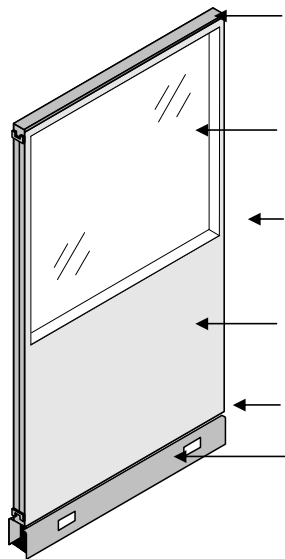

Top Cap - Made of PVC, the Top Cap finishes the top of the panel and is factory installed.

Glazed face - Is translucent acrylic insert.

Hanger Frame - Heavy gauge slotted steel rail to accommodate hanging components.

Panel face - Is fabric covered hard surface.

Wire Management cavity - Provides for data and electrical distribution.

Powered Base Covers - Are standard and removable to provide access to wire management cavity.

Actual Dimensions

Depth (Thickness)	2" at top, 3 3/8" at base
Width	24", 30", 36", 42", 48" & 60"
Height (Minimum)	62", 67" & 85"
Wire Management	5"

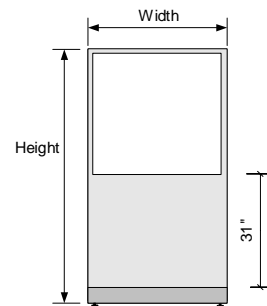

AO2 POWERED FABRIC HALF GLAZED PANEL

**Specify:**

- * Product number.
- * Wire Management color – "Y" (D=DT, M=MT)
- * Trim color – "XX" (DT, LG, MT)
- * Glazing color (BR or CL).
- * Fabric name and style number.

Note:

- * Includes Electrical Harness.
- * Order Finished End (Pg. 9.20) to finish exposed panel end.
- * Order Panel Connectors (Pgs. 9.19 - 9.20) and Festoons (Pg. 9.22) separately.
- * Fabric yardage estimate is for directional application (minimum 66" usable width).
- * Special fabrics may affect yardage requirements.

Model Number	Dimension H x W	COM	Fabric			Weight
			Grade A	Grade B	Grade C	
PANEL WITH BRONZE GLAZING						
HGGBRPY.6224XX	62 x 24	\$	1,430	\$ 1,492	\$ 1,548	40
HGGBRPY.6230XX	62 x 30	\$	1,792	\$ 1,856	\$ 1,957	42
HGGBRPY.6236XX	62 x 36	\$	1,853	\$ 1,916	\$ 2,018	49
HGGBRPY.6242XX	62 x 42	\$	2,091	\$ 2,154	\$ 2,255	53
HGGBRPY.6248XX	62 x 48	\$	2,138	\$ 2,201	\$ 2,302	58
HGGBRPY.6724XX	67 x 24	\$	1,614	\$ 1,678	\$ 1,732	41
HGGBRPY.6730XX	67 x 30	\$	1,834	\$ 1,898	\$ 2,003	44
HGGBRPY.6736XX	67 x 36	\$	1,900	\$ 1,964	\$ 2,068	50
HGGBRPY.6742XX	67 x 42	\$	2,133	\$ 2,196	\$ 2,301	54
HGGBRPY.6748XX	67 x 48	\$	2,186	\$ 2,248	\$ 2,354	59
HGGBRPY.8524XX	85 x 24	\$	1,799	\$ 1,862	\$ 1,928	52
HGGBRPY.8530XX	85 x 30	\$	2,057	\$ 2,120	\$ 2,253	58
HGGBRPY.8536XX	85 x 36	\$	2,142	\$ 2,205	\$ 2,338	63
HGGBRPY.8542XX	85 x 42	\$	2,269	\$ 2,332	\$ 2,465	68
HGGBRPY.8548XX	85 x 48	\$	2,460	\$ 2,524	\$ 2,655	72
PANEL WITH CLEAR GLAZING						
HGGCLPY.6224XX	62 x 24	\$	1,430	\$ 1,492	\$ 1,548	40
HGGCLPY.6230XX	62 x 30	\$	1,792	\$ 1,856	\$ 1,957	42
HGGCLPY.6236XX	62 x 36	\$	1,853	\$ 1,916	\$ 2,018	49
HGGCLPY.6242XX	62 x 42	\$	2,091	\$ 2,154	\$ 2,255	53
HGGCLPY.6248XX	62 x 48	\$	2,138	\$ 2,201	\$ 2,302	58
HGGCLPY.6724XX	67 x 24	\$	1,614	\$ 1,678	\$ 1,732	41
HGGCLPY.6730XX	67 x 30	\$	1,834	\$ 1,898	\$ 2,003	44
HGGCLPY.6736XX	67 x 36	\$	1,900	\$ 1,964	\$ 2,068	50
HGGCLPY.6742XX	67 x 42	\$	2,133	\$ 2,196	\$ 2,301	54
HGGCLPY.6748XX	67 x 48	\$	2,186	\$ 2,248	\$ 2,354	59
HGGCLPY.8524XX	85 x 24	\$	1,799	\$ 1,862	\$ 1,928	52
HGGCLPY.8530XX	85 x 30	\$	2,057	\$ 2,120	\$ 2,253	58
HGGCLPY.8536XX	85 x 36	\$	2,142	\$ 2,205	\$ 2,338	63
HGGCLPY.8542XX	85 x 42	\$	2,269	\$ 2,332	\$ 2,465	68
HGGCLPY.8548XX	85 x 48	\$	2,460	\$ 2,524	\$ 2,655	72

AO2 DOOR PANEL



Specify:

- * Product number.
- * Door color - (Pg. 9).
- * Panel Trim color - (DT, LG, MT).
- * Bronze or clear glazing.

Note:

- * Includes laminated door, bronze or clear glazed side panel, painted steel frame, and locking door knob with hardware.
- * Shipped assembled.
- * Lock set must be field installed.

Dimension						
Model Number	Description	Height	Width	List	Weight	
DPEL.8548XX	Left Hand Door	85"	48"	\$ 3,378	105	
DPER.8548XX	Right Hand Door	85"	48"	\$ 3,378	105	

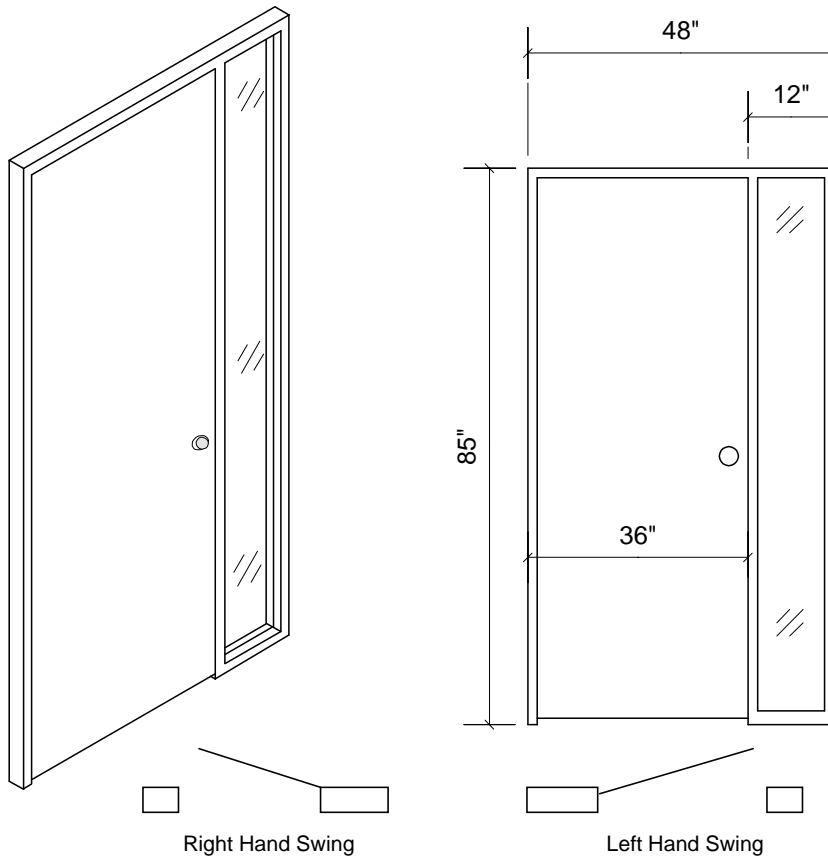

AO2 PANEL COMPONENTS

Specify:

- * Product number.
- * Finish color - "XX" (DT, LG, MT).
- * Wire Management color - "X" (D=DT, M=MT)

Note:

- * Connectors include Wire Management Trim.



	Model Number	Height	List	Weight
--	--------------	--------	------	--------

TWO WAY 90 CONNECTOR

CONNECTS TWO PANELS AT 90 DEGREES.

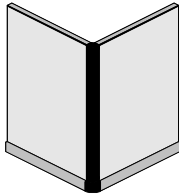

P2C.39XX	39"	\$	126	5
P2C.47XX	47"	\$	137	6
P2C.53XX	53"	\$	140	7
P2C.62XX	62"	\$	148	8
P2C.67XX	67"	\$	151	8
P2C.85XX	85"	\$	164	10

THREE WAY CONNECTOR

CONNECTS THREE PANELS AT A "T".

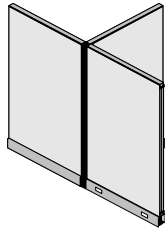

P3C.39XX	39"	\$	184	7
P3C.47XX	47"	\$	200	8
P3C.53XX	53"	\$	210	9
P3C.62XX	62"	\$	221	10
P3C.67XX	67"	\$	230	10
P3C.85XX	85"	\$	259	12

FOUR WAY CONNECTOR

CONNECTS FOUR PANELS AT AN INTERSECTION.

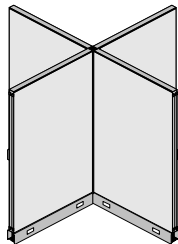

P4C.39XX	39"	\$	181	9
P4C.47XX	47"	\$	210	10
P4C.53XX	53"	\$	215	11
P4C.62XX	62"	\$	243	12
P4C.67XX	67"	\$	249	12
P4C.85XX	85"	\$	269	14

TWO WAY 180 DEGREE CONNECTOR

CONNECTS PANELS OF EQUAL OR UNEQUAL HEIGHTS FOR DIMENSIONAL GAIN.

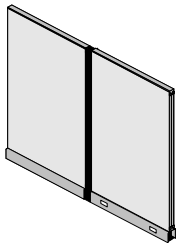

P180C.39XX	39"	\$	232	5
P180C.47XX	47"	\$	251	6
P180C.53XX	53"	\$	264	7
P180C.62XX	62"	\$	277	8
P180C.67XX	67"	\$	287	8
P180C.85XX	85"	\$	322	10

AO2 PANEL COMPONENTS

Specify:

- * Product number.
- * T-Connector and Finished End color - "XX" (DT, LG, MT).
- * Wire Management Trim color - (DT, MT).



Model Number	Height	List	Weight
--------------	--------	------	--------

PANEL CONNECTOR ROD - DT ONLY

CONNECTS TWO PANELS IN A STRAIGHT LINE.

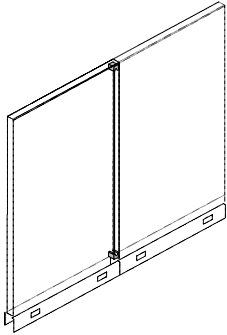

PC.39	39"	\$ 36	2
PC.47	47"	\$ 39	2
PC.53	53"	\$ 39	2
PC.62	62"	\$ 42	2
PC.67	67"	\$ 44	2
PC.85	85"	\$ 48	2

T-CONNECTOR (WALL START)

CONNECTS PANEL TO AN EXISTING STRUCTURAL WALL TO BEGIN A PANEL RUN. INCLUDES ONE (1) CONNECTOR ROD (SEE ABOVE) & WALL FASTENERS (Pg.28) SEPARATELY.

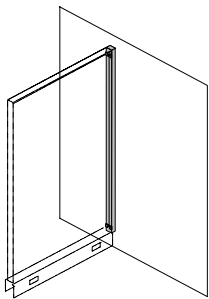

TC.39XX	39"	\$ 85	6
TC.47XX	47"	\$ 89	6
TC.53XX	53"	\$ 92	7
TC.62XX	62"	\$ 97	8
TC.67XX	67"	\$ 98	8
TC.85XX	85"	\$ 103	9
WF.4		\$ 16	2

FINISHED END

FINISHES EXPOSED PANEL END. WIRE MANAGEMENT TRIM INCLUDED.

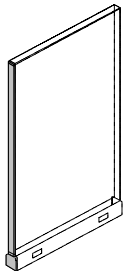

PEC.39XX	39"	\$ 55	3
PEC.47XX	47"	\$ 59	3
PEC.53XX	53"	\$ 60	3
PEC.62XX	62"	\$ 62	4
PEC.67XX	67"	\$ 64	4
PEC.85XX	85"	\$ 69	5

AO2 PANEL COMPONENTS

Specify:

* Product number.

* Product color - "XX" (DT, LG, MT).



Model Number	Description	List	Weight
--------------	-------------	------	--------

WALL HANGER STRIP

HIGH QUALITY BRUSHED ALUMINUM EXTRUSION WITH HEAVY DUTY 16 GAUGE STEEL SLOTTED INSERT IS USED TO HANG COMPONENTS OR WORK SURFACES DIRECTLY FROM A WALL. ORDER WALL FASTENERS (SEE BELOW) SEPARATELY.

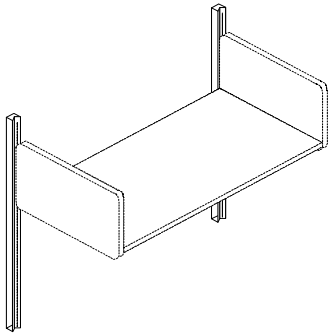

WHS.60	60" WALL STRIP	\$	92	3
WHS.72	72" WALL STRIP	\$	98	4
WHS.84	84" WALL STRIP	\$	108	4

WALL FASTENERS

USE TO FASTEN A T-CONNECTOR OR WALL HANGER STRIP TO AN EXISTING WALL.

WF.1	3/16" TOGGLE BOLT ANCHOR	\$	3.00	1
WF.2	3/16" x 3" FLAT HEAD TOGGLE BOLT	\$	1.00	1

VARIABLE HEIGHT FILLER STRIP - RIGID

FINISHES EXPOSED END OF CONNECTOR OR PANEL WHEN JOINING PANELS OF DIFFERENT HEIGHTS. CUT TO LENGTH AS REQUIRED.

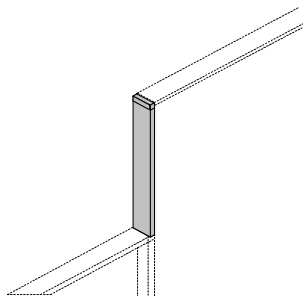

VHXX	VARIABLE HEIGHT PKG - 4' LONG	\$	30.00	1
------	-------------------------------	----	-------	---

AO2 ENERGY COMPONENTS

Specify:

- * Product number.
- * Product color -"XX" (DT, MT).

Notes: For Powered Wire Management Covers

- * Includes (2) Covers.
- * Order Electrical Harness, Festoons, and Outlet Covers separately (See Below).



Model Number	Description	List	Weight
--------------	-------------	------	--------

CONVERSION FROM NONPOWERED TO POWERED WIRE MANAGEMENT

PROVIDES EXPANDED CABLE MANAGEMENT CAPACITY AND 4 CIRCUIT ELECTRICAL CAPABILITY TO AO1 PANELS.

PWM.24XX	24" POWERED RACEWAY COVERS	\$	36	1
PWM.30XX	30" POWERED RACEWAY COVERS	\$	40	1.2
PWM.36XX	36" POWERED RACEWAY COVERS	\$	44	1.6
PWM.42XX	42" POWERED RACEWAY COVERS	\$	49	1.8
PWM.48XX	48" POWERED RACEWAY COVERS	\$	53	2
PWM.60XX	60" POWERED RACEWAY COVERS	\$	63	2.50
WMOC.XX	OUTLET COVER	\$	8	1

8 WIRE 4 CIRCUIT ELECTRICAL HARNESS

USE WITH POWERED WIRE MANAGEMENT TO DISTRIBUTE 4 OPEN 20 AMP CIRCUITS. UP TO FOUR RECEPTACLES CAN BE PLACED ON EACH PANEL. ORDER FESTOON CABLES SEPARATELY. (SEE BELOW)

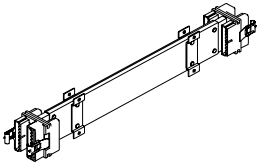

8WP.24	24" ELECTRICAL HARNESS	\$	197	2
8WP.30	30" ELECTRICAL HARNESS	\$	210	2
8WP.36	36" ELECTRICAL HARNESS	\$	221	2
8WP.42	42" ELECTRICAL HARNESS	\$	231	3
8WP.48	48" ELECTRICAL HARNESS	\$	238	4
8WP.60	60" ELECTRICAL HARNESS	\$	267	5

FESTOONS

CONNECTS POWER BETWEEN PANELS ONLY, OR BETWEEN PANELS CONNECTED BY A 2-WAY, 3-WAY, 4-WAY, OR SPACER POST.

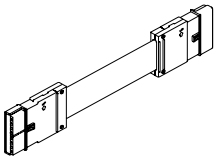

8.PTP	11" PANEL TO PANEL	\$	80	2
8.PTC	14" PANEL THRU POST	\$	95	2

AO2 ENERGY COMPONENTS

Specify:

* Product number.

* Receptacle color – "YY" (BK, MT)



Model Number	Description	List	Weight
--------------	-------------	------	--------

PASS THRU JUMPERS

USE THIS FLEXIBLE CONDUIT CABLE TO PASS POWER THROUGH A NONPOWERED PANEL TO CONNECT WITH ANOTHER ELECTRICAL HARNESS.

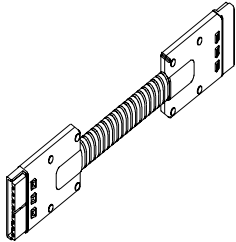

8PJ.12	12" PASS THRU	\$	180	1
8PJ.18	18" PASS THRU	\$	191	1
8PJ.24	24" PASS THRU	\$	201	1
8PJ.30	30" PASS THRU	\$	211	1
8PJ.36	36" PASS THRU	\$	221	2
8PJ.42	42" PASS THRU	\$	227	2
8PJ.48	48" PASS THRU	\$	232	3
8PJ.60	60" PASS THRU	\$	422	3
8PJ.72	72" PASS THRU	\$	427	3
8PJ.80	80" PASS THRU	\$	438	4
8PJ.96	96" PASS THRU	\$	469	4
8PJ.108	108" PASS THRU	\$	489	4
8PJ.132	132" PASS THRU	\$	510	5
8PJ.144	144" PASS THRU	\$	260	5

POWER ENTRY

CONNECTS A BUILDING'S ELECTRICAL SUPPLY FROM THE CEILING, WALL, OR FLOOR TO THE BASE OF A PANEL.

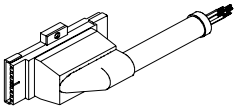

8PFR.72	72" POWER FEED-RIGHT	\$	222	4
8PFL.72	72" POWER FEED-LEFT	\$	222	4
8CF.144	144" CEILING INFEEED	\$	184	5

8 WIRE, 4 CIRCUIT ELECTRICAL RECEPTACLES

PLUGS INTO THE ELECTRICAL HARNESS. SELECT CIRCUITS 1, 2, 3, DC.

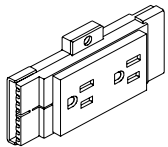

8C1.XX	CIRCUIT 1	\$	33	1
8C2.XX	CIRCUIT 2	\$	33	1
8C3.XX	CIRCUIT 3	\$	33	1
8DC.XX	DEDICATED CIRCUIT	\$	33	1

AO2 ENERGY COMPONENTS



Specify:

- * Product number.
- * Product color - "XX" ((DT, LG, MT)

Model Number	Description	List	Weight
--------------	-------------	------	--------

POWER POLES

BASIC POWER POLE

HOLLOW, RIGID 11 FOOT PVC EXTRUSION USED TO CONCEAL CEILING POWER INFEED, OR COMMUNICATION AND DATA DISTRIBUTION CABLES. HARDWARE INCLUDED TO MOUNT POLE TO END OF PANEL RUN. ORDER BY SIZE OF CONNECTING PANEL.

ORDER CEILING POWER INFEED (Pg. 30) SEPARATELY.

PP.XX	POWER POLE ONLY	\$	216	15
8PP.34XX	POWER POLE HARDWARE	\$	247	20
8PP.42XX	POWER POLE HARDWARE	\$	258	20
8PP.48XX	POWER POLE HARDWARE	\$	268	20
8PP.62XX	POWER POLE HARDWARE	\$	288	23
8PP.80XX	POWER POLE HARDWARE	\$	298	25

LARGE POWER POLE

HOLLOW, 3" x 4" RIGID 12 FOOT PVC EXTRUSION USED TO CONCEAL CEILING POWER INFEED, OR COMMUNICATION AND DATA DISTRIBUTION CABLES. HARDWARE INCLUDED TO MOUNT POLE TO END OF PANEL RUN. ORDER BY SIZE OF CONNECTING PANEL. INCLUDES BASE TRIM AND CEILING BEZEL. DOES NOT ICLUDE PANEL CONNECTING HARDWARE

ORDER CEILING POWER INFEED (Pg. 30) SEPARATELY.

PPL.XX	POWER POLE ONLY	\$	216	15
8PPL.34XX	POWER POLE HARDWARE	\$	247	20
8PPL.42XX	POWER POLE HARDWARE	\$	258	20
8PPL.48XX	POWER POLE HARDWARE	\$	268	20
8PPL.62XX	POWER POLE HARDWARE	\$	288	23
8PPL.80XX	POWER POLE HARDWARE	\$	298	25

NOTE: Available in BU or MT only.

AO2 WORK SURFACE TOPS



Specify:

- * Product number.
- * Edge finishes (DT, HF, HT, LG, LN, LT, MT)
- * Laminate finishes (Pg. 88)
- * Special laminate colors available upon request.

Note:

- * Tops, only.
- * Order Supports (Pg.9.22) separately.

	Model Number	Description	List	Weight
RECTANGULAR WORK SURFACE TOPS				
	WS.2424	24 x 24	\$ 237	22
	WS.3024	30 x 24	\$ 298	28
	WS.3624	36 x 24	\$ 308	33
	WS.4224	42 x 24	\$ 375	39
	WS.4824	48 x 24	\$ 402	44
	WS.6024	60 x 24	\$ 510	55
	WS.7224	72 x 24	\$ 582	66
	WS.2430	24 x 30	\$ 309	28
	WS.3030	30 x 30	\$ 351	35
	WS.3630	36 x 30	\$ 407	42
WS.4230	42 x 30	\$ 448	49	
WS.4830	48 x 30	\$ 460	55	
WS.6030	60 x 30	\$ 572	69	
WS.7230	72 x 30	\$ 693	82	

CORNER WORK SURFACE TOPS

USE FOR 90 DEGREE CORNERS.

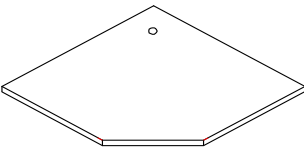

36 x 24
36 x 30, 42 x 30

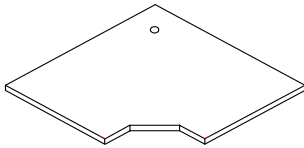

42 x 24, 48 x 24
48 x 30

CWS.3624	36 x 24	\$ 557	49
CWS.4224	42 x 24	\$ 630	67
CWS.4824	48 x 24	\$ 668	88
CWS.3630	36 x 30	\$ 561	53
CWS.4230	42 x 30	\$ 645	70
CWS.4830	48 x 30	\$ 690	91

AO2 WORK SURFACE TOPS



Specify:

- * Product number.
- * Edge finishes (DT, HF, HT, LG, LN, LT, MT)
- * Laminate finishes (Pg. 88).
- * Special laminate colors available upon request.

Note:

- * Tops, only.
- * Order Supports (Pg. 9.22) separately.

Model Number	Description	List	Weight
--------------	-------------	------	--------

PENINSULA WORK SURFACE TOPS

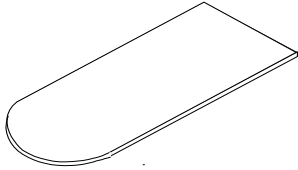

WSP.3048	30 x 48	\$	518	60
WSP.3054	30 x 54	\$	555	65
WSP.3060	30 x 60	\$	616	69
WSP.3066	30 x 66	\$	707	75
WSP.3072	30 x 72	\$	741	83
WSP.3648	36 x 48	\$	592	83
WSP.3654	36 x 54	\$	650	85
WSP.3660	36 x 60	\$	741	88
WSP.3666	36 x 66	\$	810	95
WSP.3672	36 x 72	\$	888	99

COUNTER CAP TOPS

USE ON PANEL CAPS AS TRANSACTION COUNTER FOR SECRETARIAL AND RECEPTION WORKSTATIONS.

NOTE: ORDER SURFACE WIDTH TO MATCH WIDTH OF PANEL OR PANELS.

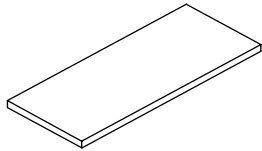

Rectangle

CC.1424	14 x 24	\$	161	14
CC.1430	14 x 30	\$	198	18
CC.1436	14 x 36	\$	235	21
CC.1442	14 x 42	\$	272	25
CC.1448	14 x 48	\$	297	28
CC.1460	14 x 60	\$	358	35
CC.1472	14 x 72	\$	409	42

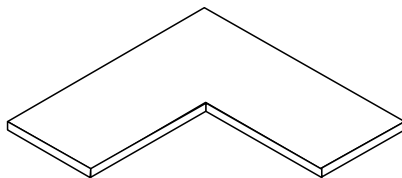

Right Angle

RACC.2424	24 x 24 x 14	\$	349	20
RACC.4848	48 x 48 x 14	\$	897	55

AO2 WORK SURFACE SUPPORTS



Specify:

- * Product number.
- * Product color - "XX" (DT, LG, MT)

Note:

- * Counter Cap Supports and Corner Work Surface Brackets come in black only.

	Model Number	Description	List	Weight
<p>Counter Support</p>	WSA.24SXX	SUPPORT ARM - SHARED	\$ 68	5
	WSA.24XX	SUPPORT ARM - PAIR	\$ 68	6
	WSA.30SXX	SUPPORT ARM - SHARED	\$ 98	5
	WSA.30XX	SUPPORT ARM - PAIR	\$ 98	8
<p>Counter Cap Support</p>	CCCS.01XX	COUNTER CAP SUPPORT - CENTER	\$ 74	3
	CCCS.02XX	COUNTER CAP SUPPORT - MID END	\$ 74	3
	CCCS.03XX	COUNTER CAP SUPPORT - END	\$ 74	3
<p>Corner Bracket</p>	WSCB.01LBK	CORNER W. S. BRACKET - LEFT	\$ 26	1
	WSCB.01RBK	CORNER W. S. BRACKET - RIGHT	\$ 26	1
<p>Peninsula Leg</p>	APL4.XX	ADJUSTABLE PENINSULA LEG	\$ 250	10

Specify:

- * Product number.
- * Support Panel depth to match work surface depth.
- * Laminate finish (Pg. 88)

Note:

- * Support Panel is non-handed
- * Includes attachment hardware and 2" adjustable glides.
- * Height is 28".

WORK SURFACE SUPPORT PANEL END

PANEL END HAS LAMINATE SURFACE AND ATTACHES TO BOTH A PANEL AND WORK SURFACE AT THE END OF A PANEL RUN TO PROVIDE SUPPORT AND ELIMINATE THE NEED FOR A RETURN PANEL AND CONNECTOR.

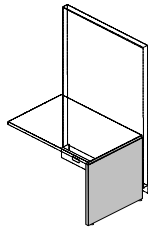

WSSP.24	24" Deep	\$ 368	20
WSSP.30	30" Deep	\$ 479	27

AO2 WORK SURFACES

Specify:

- * Product number.
- * Edge finishes (DT, HF, HT, LG, LN, LT, MT)
- * Laminate finishes (Pg. 88)
- * Special laminate colors available upon request.
- * Support Arm finishes (DT, LG, MT)

Note:

- * Includes Support Hardware.



Model Number	Description	List	Weight
--------------	-------------	------	--------

RECTANGULAR WORK SURFACES

CAN BE SUPPORTED BY PANELS OR WALL HANGER STRIPS.

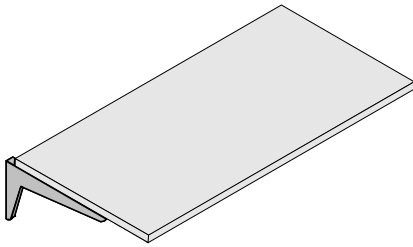

AWS.2424	24 x 24	\$	288	26
AWS.2430	24 x 30	\$	356	31
AWS.2436	24 x 36	\$	361	36
AWS.2442	24 x 42	\$	433	40
AWS.2448	24 x 48	\$	448	44
AWS.2460	24 x 60	\$	571	55
AWS.2472	24 x 72	\$	626	67
AWS.3024	30 x 24	\$	383	34
AWS.3030	30 x 30	\$	425	37
AWS.3036	30 x 36	\$	480	46
AWS.3042	30 x 42	\$	522	52
AWS.3048	30 x 48	\$	535	55
AWS.3060	30 x 60	\$	683	70
AWS.3072	30 x 72	\$	804	83

CORNER WORKSURFACE

USE FOR 90 DEGREE CORNERS. CORNER BRACKETS INCLUDED.

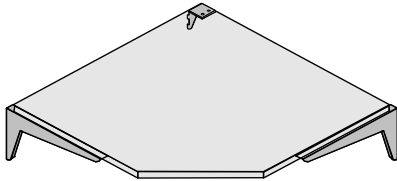

36 x 24
36 x 30, 42 x 30

ACWS.2436	24 x 36	\$	620	50
ACWS.2442	24 x 42	\$	694	61
ACWS.2448	24 x 48	\$	712	73
ACWS.3036	30 x 36	\$	652	53
ACWS.3042	30 x 42	\$	735	65
ACWS.3048	30 x 48	\$	781	76

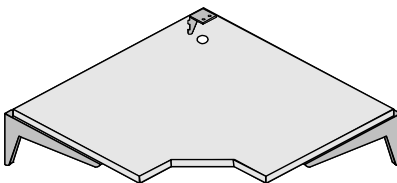

42 x 24, 48 x 24
48 x 30

AO2 WORK SURFACES

Specify:

- * Product number.
- * Edge finishes (DT, HF, HT, LG, LN, LT, MT)
- * Laminate finishes (Pg. 88).
- * Special laminate colors available upon request.
- * Support Arm finishes (DT, LG, MT).
- * Peninsula Leg finishes (DT, LG, MT).

Note:

- * Includes Support Hardware.



Model Number	Description	List	Weight
--------------	-------------	------	--------

PENINSULA WORK SURFACE

CAN BE SUPPORTED BY PANELS OR WALL HANGER STRIPS. 4" ADJUSTABLE PENINSULA LEG INCLUDED.

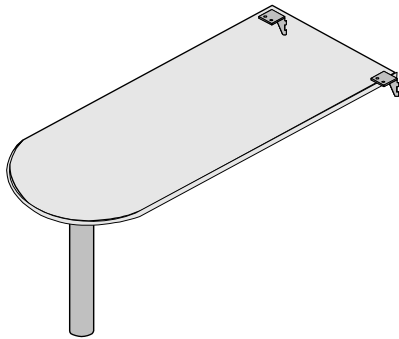

AP.3048	30 x 48	\$	988	60
AP.3054	30 x 54	\$	1,028	65
AP.3060	30 x 60	\$	1,095	69
AP.3066	30 x 66	\$	1,105	75
AP.3072	30 x 72	\$	1,120	83
AP.3648	36 x 48	\$	987	83
AP.3654	36 x 54	\$	1,050	85
AP.3660	36 x 60	\$	1,119	88
AP.3666	36 x 66	\$	1,194	95
AP.3672	36 x 72	\$	1,301	99

COUNTER CAP

USE ON PANEL CAPS AS TRANSACTION COUNTER FOR SECRETARIAL AND RECEPTION WORKSTATIONS.

NOTE: ORDER SURFACE WIDTH TO MATCH WIDTH OF PANEL OR PANELS.

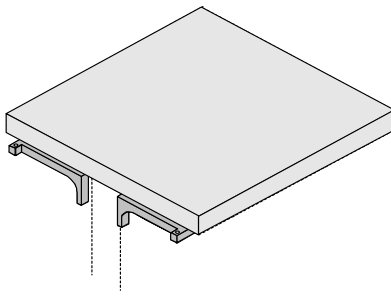

Rectangle

Rectangle

ACC.1424	14 x 24	\$	259	19
ACC.1430	14 x 30	\$	271	22
ACC.1436	14 x 36	\$	282	30
ACC.1442	14 x 42	\$	289	40
ACC.1448	14 x 48	\$	296	43
ACC.1460	14 x 60	\$	359	55
ACC.1472	14 x 72	\$	409	65

Right Angle

ARACC.2424	24 x 24 x 14	\$	447	20
ARACC.4848	48 x 48 x 14	\$	732	55

AO2 TABLES

Specify:

- * Product number.
- * Size of Table.
- * Edge finishes (DT, HF, HT, LG, LN, LT, MT)
- * Laminate finishes (Pg. 88).
- * Special laminate colors available upon request.
- * Round Table Base finishes (DT, LG, MT)
- * Training Table Base finish is black only.

Note:

- * Tables include laminate top with 3mm vinyl edge.
- * Height is 29"
- * Thickness is 1.25"



Model Number	Description	List	Weight
--------------	-------------	------	--------

ROUND MEETING TABLES

INCLUDES A 2" DIAMETER ROUND TUBE BASE.

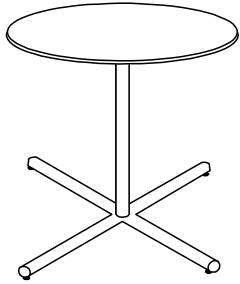

ART.30	30"	\$	719	36
ART.36	36"	\$	798	50
ART.42	42"	\$	898	69
ART.48	48"	\$	998	83

TRAINING TABLES

INCLUDES A MODESTY PANEL AND "C" LEGS WITH CABLE ACCESS PANELS.

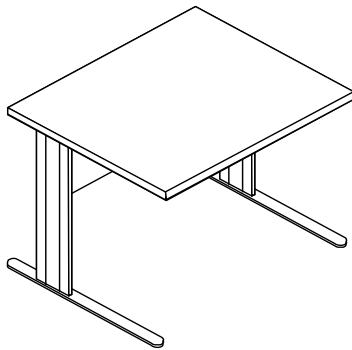

30 x 36"	ATT.3036	\$	703	\$	73
30 x 42"	ATT.3042	\$	759	\$	82
30 x 48"	ATT.3048	\$	780	\$	88
30 x 54"	ATT.3054	\$	858	\$	100
30 x 60"	ATT.3060	\$	888	\$	109
30 x 66"	ATT.3066	\$	936	\$	115
30 x 72"	ATT.3072	\$	975	\$	124
30 x 84"	ATT.3084	\$	1,250	\$	160

AO2 OVERHEAD STORAGE

Specify:

- * Product number.
- * Product color – "XX" (DT, LG, MT).
- * Fabric style & color number.
- * Shelf End color, if different from Shelf and top of Unit.

Note:

- * Flipper Door is lockable.
- * Locks can be keyed alike upon request.
- * Shipped partially assembled.
- * Fabric yardage estimate is for directional application (minimum 66" usable width).
- * Special fabrics may affect yardage requirements.



Model Number	Description	COM	Fabric Grade1	Grade 2	Weight
--------------	-------------	-----	---------------	---------	--------

FLIPPER DOOR UNIT, FABRIC

INCLUDES SHELF, HIGH SHELF ENDS, AND FLIPPER DOOR COVERED IN FABRIC.

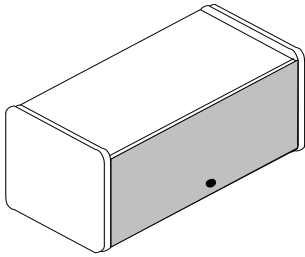

FDU.24XX	24 x 12.5 x 15.5	\$	438 \$	446 \$	466	41
FDU.30XX	30 x 12.5 x 15.5	\$	451 \$	455 \$	475	45
FDU.36XX	36 x 12.5 x 15.5	\$	462 \$	471 \$	490	50
FDU.42XX	42 x 12.5 x 15.5	\$	484 \$	489 \$	502	53
FDU.48XX	48 x 12.5 x 15.5	\$	514 \$	520 \$	530	55
FDU.60XX	60 x 12.5 x 15.5	\$	615 \$	621 \$	641	64

FLIPPER DOOR, FABRIC

ORDER HIGH SHELF (Pg. 39) TO FORM COMPLETE FLIPPER UNIT.

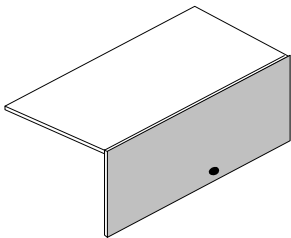

FD.24XX	24 x 12.5	\$	272 \$	277 \$	297	20
FD.30XX	30 x 12.5	\$	276 \$	281 \$	301	22
FD.36XX	36 x 12.5	\$	281 \$	288 \$	308	23
FD.42XX	42 x 12.5	\$	285 \$	290 \$	310	24
FD.48XX	48 x 12.5	\$	299 \$	309 \$	318	25
FD.60XX	60 x 12.5	\$	387 \$	394 \$	414	28

AO2 OVERHEAD STORAGE

Specify:

- * Product number.
- * Product color--"YY" (DT, LG, MT)
- * Shelf End color, if different from Shelf.

Note:

- * Includes Shelf and Shelf Ends.
- * Shipped one per box.
- * Shipped unassembled.



Model Number	Description	List	Weight
--------------	-------------	------	--------

HIGH SHELF

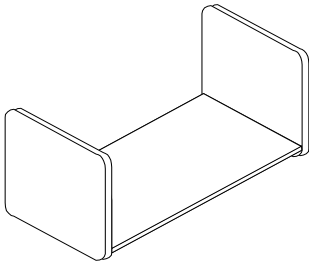

HS.24XX	24 x 12.5 x 15.5	\$	161	21
HS.30XX	30 x 12.5 x 15.5	\$	168	23
HS.36XX	36 x 12.5 x 15.5	\$	180	27
HS.42XX	42 x 12.5 x 15.5	\$	196	29
HS.48XX	48 x 12.5 x 15.5	\$	216	30
HS.60XX	60 x 12.5 x 15.5	\$	227	36

LOW SHELF - 7 1/2 " HIGH

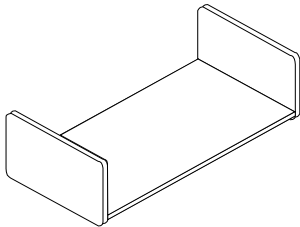

LS.24XX	24 x 12.5 x 7.5	\$	155	20
LS.30XX	30 x 12.5 x 7.5	\$	160	22
LS.36XX	36 x 12.5 x 7.5	\$	170	26
LS.42XX	42 x 12.5 x 7.5	\$	191	28
LS.48XX	48 x 12.5 x 7.5	\$	211	29
LS.60XX	60 x 12.5 x 7.5	\$	221	35

AO2 OVERHEAD STORAGE

Specify:

- * Product number.
- * Product color – “YY” (DT, LG, MT).
- * Fabric style & color number.
- * Shelf End color, if different from Shelf and top of Unit.

Note:

- * Flipper Door is lockable.
- * Locks can be keyed alike upon request.
- * Shipped partially assembled.
- * Fabric yardage estimate is for directional application (minimum 66” usable width).
- * Special fabrics may affect yardage requirements.



Model Number	Description	Grade 1	Fabric Grade 2	Com	Weight
--------------	-------------	---------	----------------	-----	--------

DEEP FLIPPER DOOR UNIT, FABRIC

INCLUDES SHELF, HIGH SHELF ENDS, AND FLIPPER DOOR COVERED IN FABRIC.

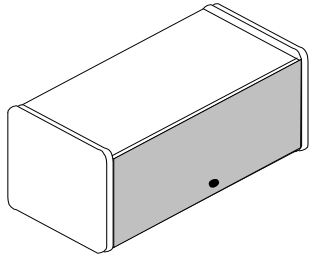

DFDU.24XX	24 x 15.5 x 15.5	\$ 618	\$ 650	588	48
DFDU.30XX	30 x 15.5 x 15.5	\$ 638	\$ 670	627	52
DFDU.36XX	36 x 15.5 x 15.5	\$ 672	\$ 705	663	57
DFDU.42XX	42 x 15.5 x 15.5	\$ 695	\$ 730	685	60
DFDU.48XX	48 x 15.5 x 15.5	\$ 718	\$ 750	712	62
DFDU.60XX	60 x 15.5 x 15.5	\$ 766	\$ 799	755	71

DEEP FLIPPER DOOR, FABRIC

ORDER HIGH SHELF (Pg. 41) TO FORM COMPLETE FLIPPER UNIT.

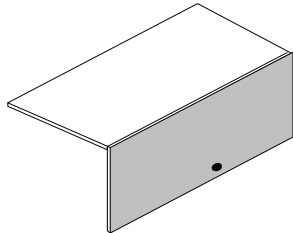

DFD.24XX	24 x 15.5	\$ 387	\$ 419	368	24
DFD.30XX	30 x 15.5	\$ 399	\$ 432	382	26
DFD.36XX	36 x 15.5	\$ 424	\$ 455	393	27
DFD.42XX	42 x 15.5	\$ 440	\$ 478	408	28
DFD.48XX	48 x 15.5	\$ 454	\$ 490	427	29
DFD.60XX	60 x 15.5	\$ 485	\$ 526	454	32

AO2 OVERHEAD STORAGE



Specify:

- * Product number.
- * Product color—"YY" (DT, LG, MT)
- * Shelf End color, if different from Shelf.

Note:

- * Includes Shelf and Shelf Ends
- * Shipped one per box.
- * Shipped unassembled.

	Model Number	Description	List	Weight
DEEP HIGH SHELF				
	DHS.24XX	24 x 15.5 x 15.5	\$ 221	24
	DHS.30XX	30 x 15.5 x 15.5	\$ 228	26
	DHS.36XX	36 x 15.5 x 15.5	\$ 236	30
	DHS.42XX	42 x 15.5 x 15.5	\$ 244	32
	DHS.48XX	48 x 15.5 x 15.5	\$ 252	33
	DHS.60XX	60 x 15.5 x 15.5	\$ 268	39

DEEP LOW SHELF - 7 1/2 " HIGH

	DLS.24XX	24 x 15.5 x 7.5	\$ 217	23
	DLS.30XX	30 x 15.5 x 7.5	\$ 225	25
	DLS.36XX	36 x 15.5 x 7.5	\$ 233	29
	DLS.42XX	42 x 15.5 x 7.5	\$ 240	31
	DLS.48XX	48 x 15.5 x 7.5	\$ 248	32
	DLS.60XX	60 x 15.5 x 7.5	\$ 264	38

METAL FLIPPER DOOR UNIT WITH LOCK

INCLUDES SHELF, HIGH SHELF ENDS, AND METAL FLIPPER DOOR.

	MFDU.24XX	24 x 12.5 x 15.5	\$ 715	\$ 26	
	MFDU.30XX	30 x 12.5 x 15.5	\$ 733	\$ 32	
	MFDU.36XX	36 x 12.5 x 15.5	\$ 759	\$ 39	
	MFDU.42XX	42 x 12.5 x 15.5	\$ 803	\$ 45	
	MFDU.48XX	48 x 12.5 x 15.5	\$ 865	\$ 51	
	MFDU.60XX	60 x 12.5 x 15.5	\$ 1,067	\$ 64	
	DOOR RECEEDS INTO THE CABINET				
	MFDUT.24XX	24 x 12.5 x 15.5	\$ 599	\$ 26	
	MFDUT.30XX	30 x 12.5 x 15.5	\$ 617	\$ 32	
	MFDUT.36XX	36 x 12.5 x 15.5	\$ 634	\$ 39	
MFDUT.42XX	42 x 12.5 x 15.5	\$ 688	\$ 45		
MFDUT.48XX	48 x 12.5 x 15.5	\$ 732	\$ 51		
MFDUT.60XX	60 x 12.5 x 15.5	\$ 900	\$ 64		

DOOR OPENS OVER THE TOP OF CABINET

Note:

- * Locks can be keyed alike upon request.
- * Shipped one per box.
- * Ready to install.
- * Door recesses under flipper top.

AO2 TACKBOARDS



Specify:

- * Product number.
- * Fabric style and number.

Note:

- * Fabric covered.
- * Includes all hardware for mounting.
- * Fabric yardage estimate is for directional application (minimum 66" usable width).
- * Special fabrics may affect yardage requirements.

Model Number	Description	COM	Fabric Grade 1	Grade 2	Weight
PTB.1224	12 x 24	\$ 155	\$ 171	\$ 184	7
PTB.1230	12 x 30	\$ 166	\$ 183	\$ 196	8
PTB.1236	12 x 36	\$ 174	\$ 191	\$ 203	9
PTB.1242	12 x 42	\$ 181	\$ 199	\$ 211	10
PTB.1248	12 x 48	\$ 183	\$ 201	\$ 213	11
PTB.1260	12 x 60	\$ 193	\$ 209	\$ 222	12
PTB.1624	16 x 24	\$ 158	\$ 174	\$ 187	8
PTB.1630	16 x 30	\$ 168	\$ 184	\$ 197	9
PTB.1636	16 x 36	\$ 178	\$ 195	\$ 207	10
PTB.1642	16 x 42	\$ 185	\$ 202	\$ 214	11
PTB.1648	16 x 48	\$ 191	\$ 207	\$ 220	12
PTB.1660	16 x 60	\$ 198	\$ 214	\$ 227	3
PTB.2424	24 x 24	\$ 238	\$ 254	\$ 267	15
PTB.2448	24 x 48	\$ 299	\$ 309	\$ 324	22
PTB.3636	36 x 36	\$ 351	\$ 376	\$ 418	23
PTB.4848	48 X 48	\$ 451	\$ 504	\$ 522	22

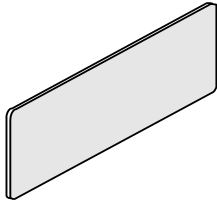

METAL FRONT PEDESTALS

Specify:

- * Product number.
- * Product color - "YY" (DT, LG, MT, BK).

Note:

- * Pedestals come with a lock and have radius metal drawer fronts.
- * All files are 15.19" wide.
- * Box drawers have 3/4" slides.
- * File drawers have full extension.
- * Support Pedestals have fully adjustable 1" leveling legs.



Model Number	Description	List	Weight
--------------	-------------	------	--------

**WORK SURFACE SUPPORTING PEDESTAL
24" DEEP**

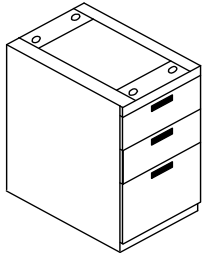

CSP20.FF.XX	FILE/FILE	\$ 515	62
CSP20.BF.XX	BOX/BOX/FILE	\$ 515	62
CSP24.FF.XX	FILE/FILE	\$ 613	66
CSP24.BF.XX	BOX/BOX/FILE	\$ 659	66

**MOBILE PEDESTAL
20" DEEP**

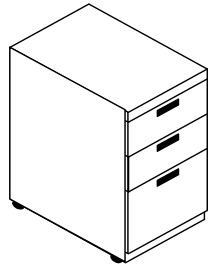

CMP20.B.XX	BOX/FILE	\$ 695	45
CMP20.FF.XX	FILE/FILE	\$ 824	70
CMP20.BF.XX	BOX/BOX/FILE	\$ 876	70

DRAWER DIVIDER FOR METAL PEDESTALS

METAL PARTITION SLIDES INTO PRE-MEASURED AND PRE-CUT DRAWER SLOTS. FINISH: BLACK ONLY.

BDD	BOX DIVIDER - 6"	\$ 15	1
FDD	FILE DIVIDER - 12"	\$ 22	1
UT6	UTILITY TRAY - 6"	\$ 18	1

METAL FRONT LATERAL FILES

Specify:

- * Product number.
- * Product color - "YY" (DT, LG, MT, BK).

Note:

- * Files are equipped with center lock, full extension slides, and leveling legs.
- * Includes drawer interlock feature.
- * Meets or exceeds BIFMA standards.



Model Number	Description	List	Weight
--------------	-------------	------	--------

TWO DRAWER LATERAL

CLF.230.XX	30"	\$ 1,196	140
CLF.236.XX	36"	\$ 1,306	150
CLF.242.XX	42"	\$ 1,428	160

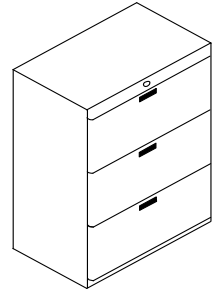
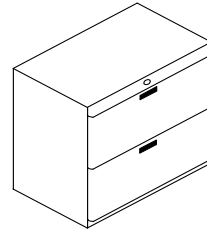

THREE DRAWER LATERAL

CLF.330.XX	30"	\$ 1,567	170
CLF.336.XX	36"	\$ 1,720	190
CLF.342.XX	42"	\$ 1,849	210

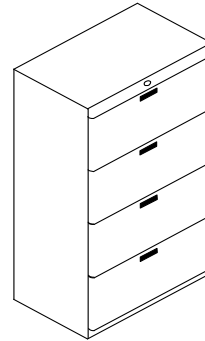

FOUR DRAWER LATERAL

CLF.430.XX	30"	\$ 1,873	205
CLF.436.XX	36"	\$ 2,105	230
CLF.442.XX	42"	\$ 2,343	260

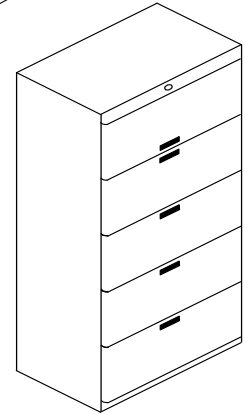

FIVE DRAWER LATERAL

CLF.530.XX	30"	\$ 2,412	240
CLF.536.XX	36"	\$ 2,704	270
CLF.542.XX	42"	\$ 2,982	310

LATERAL FILE CONVERSION BAR - BK ONLY

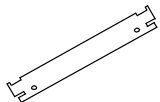

LFCB	FRONT TO BACK FILING	\$ 10	1
------	----------------------	-------	---

FILE CENTER

PFC.30.XX	30"	\$ 1,513	160
-----------	-----	----------	-----

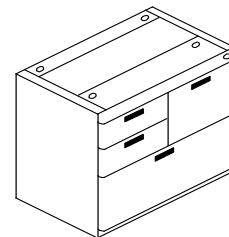

ACCESSORIES

Specify:

- * Product number.
- * Product color – “YY” (DT, LG, MT)

Note:

- * Tasklights include: switch, 9' power cord assembly and a fluorescent bulb.
- * For use under standard 12" deep Shelf.



	Model Number	Description	List	Weight
--	--------------	-------------	------	--------

TASKLIGHT

COMPLETE WITH MOUNTING BRACKETS - READY TO INSTALL



TL.24XX	21.5	\$	190	3
TL.30XX	27.5	\$	200	3
TL.36XX	33.5	\$	210	4
TL.42XX	42.5	\$	215	4
TL.48XX	48.5	\$	225	4
TL.60XX	57.5	\$	260	5

CORD MANAGER

3/4" EXTRUDED PLASTIC LATCH CHANNEL IS USED TO CONCEAL CORDS ABOVE OR BELOW WORK SURFACE. AVAILABLE IN 4' LENGTHS.

	ACM.4	CORD MANAGER	\$	14.00	0.1
--	-------	--------------	----	-------	-----

PAPER MANAGEMENT

TOOL BAR WITH VARIOUS ATTACHING COMPONENTS CAN BE USED FOR ORGANIZING A WORK AREA BY CREATING QUICKLY ACCESSIBLE STORAGE ABOVE THE WORK SURFACE. TOOL BAR IS MADE OF EXTRUDED ALUMINUM. COMPONENTS ARE INJECTION MOLDED, HIGHLY DURABLE PLASTIC.



Tool Bar

	ATB.36BK	36" WIDE TOOL BAR	\$	127	3
	ATB.48BK	48" WIDE TOOL BAR	\$	150	4

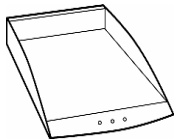

Paper Tray

	APT.BK	10" WIDE PAPER TRAY	\$	35	1
	AHFF.BK	HANGING FILE FOLDER	\$	15	0.5
	AFH.BK	FOLDER HOLDER	\$	42	1

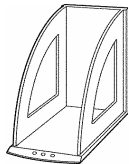

Binder Holder

	ABH.BK	BINDER HOLDER	\$	25	1
	APH.BK	PENCIL HOLDER	\$	15	0.5

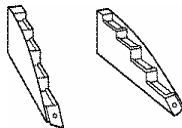

File Folder

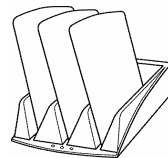

Folder Holder

Pencil Holder

ACCESSORIES

**Specify:**

* Product number.

	Model Number	Description	List	Weight
	MB.2424	24 x 24	\$ 340	45
	MB.4824	48 x 24	\$ 425	80
	MB.3636	36 x 36	\$ 485	65
	MB.4848	48 x 36	\$ 690	110

MARKERBOARDS

DATA/VOICE JACK COVERS & JACKS

USE WITH NONPOWERED PANELS AS CONFIGURED BELOW. COVERS CAN ALSO BE USED WITH CUSTOMER'S JACKS.
COVERS FIT IN RECEPTACLE OPENINGS.

Specify:

* Product number.

* Product color—"XX" (DT, MT)

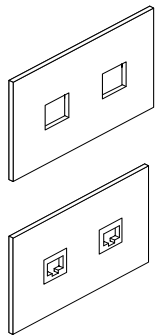

DJC.XX	COVER ONLY WITH TWO SQUARE HOLES FOR RJ-11 OR RJ-45 JACKS	\$ 14	1
DJC.RJ11RJ45.XX	COVER WITH ONE RJ-11 & ONE RJ-45 JACK INCLUDED.	\$ 119	1
DJC.RJ45RJ45.XX	COVER WITH TWO RJ-45 JACKS INCLUDED.	\$ 230	1

STANDARD LAMINATES AND TEXTILES**STANDARD LAMINATES**

ANY STANDARD WILSONART LAMINATE

**STANDARD PANEL TEXTILES - GRADE A****ADVANTAGE**66" Wide
100% Polyester

ADV101 Sage
 ADV103 Seaspray
 ADV104 Ecru
 ADV106 Silver
 ADV108 Celestial
 ADV110 Stone
 ADV111 Metal

HAMPSHIRE66" Wide
100% Polyester**REFLECTANCE**66" Wide
100% Polyester

R1658 Rose Quartz
 R1913 Graphite
 R1914 Flint
 R1916 Moonstone
 R1917 Pumice
 R1926 Opal
 R1927 Pearl
 R2407 Azurite
 R2959 Amethyst
 R2971 Blue Zircon
 R2976 Lapis
 R2978 Spinel
 R2989 Sapphire
 R5846 Garnet
 R6337 Travertine
 R6339 Tourmaline
 R6358 Topaz
 R6687 Jasper
 R7851 Copper
 R7854 Carnelian
 R8069 Galena
 R8081 Serpentine
 R8426 Feldspar
 R8427 Limestone

AxisToo66" Wide
100% Polyester

AXT10 Crystal
 AXT11 Saffron
 AXT12 Sand
 AXT13 Slate
 AXT14 Patina
 AXT15 Cypress
 AXT16 Meadow
 AXT17 Copper
 AXT18 Cobalt
 AXT19 Mediterranean
 AXT20 Thistle
 AXT21 Stone
 AXT22 Bisque
 AXT23 Curry
 AXT24 Shale
 AXT25 Oxygen
 AXT26 Melba
 AXT27 Quarry

GENESIS 70166" Wide
100% Polyester

GS150 Wedgewood
 GS153 Baltic
 GS173 Rose
 GS174 Wine
 GS175 Crystal Blue
 GS238 Grey Mix
 GS254 Oatmeal
 GS298 Medium Grey
 GS380 Quartz
 GS381 Aquamarine
 GS382 Garnet
 GS390 Rose Quartz
 GS394 Opal
 GS400 Cherry Neutral
 GS401 Blue Neutral
 GS402 Green Neutral
 GS404 Apricot Neutral
 GS405 Lavender Neutral
 GS406 Silver Neutral
 GS424 Amethyst
 GS438 Dark Spruce
 GS470 Ultramarine
 GS479 Quarry
 GS533 Tan I
 GS538 Silver Papier
 GS539 Blue Papier
 GS936 Violet
 GS945 Azur

STANDARD PANEL TEXTILES - continued

**GRADE B****ACCLAIM**

66" Wide
100% Polyester

AC10 Sunray
AC11 Pewter
AC12 Pebble
AC13 Sterling
AC14 Leek
AC15 Chamomile
AC16 Orchid
AC17 Bluejay
AC18 Fern
AC19 Goldenrod
AC20 Crabapple
AC21 Night
AC22 Juniper

DEL MAR

66" Wide
100% Polyester

DM600 Whisper Blue
DM601 Linen
DM602 Tussah
DM603 Mercury
DM604 Desert
DM605 Terra
DM606 Teaberry
DM607 Shale
DM608 Leaf
DM609 Redrock
DM610 Peacock
DM611 Cashmere
DM612 Iris
DM613 Harvest

GRADE C**DIVIDEND**

66" Wide - Directional
100% Polyester

BG100 Nebula
BG101 Vapor Green
BG102 Constellation
BG103 Orbit
BG104 Sky
BG105 Starry
BG106 Luna
BG107 Cumulus
BG108 Stella

RADIX

66" Wide
100% Polyester

RX10 Teal
RX11 Ecru
RX12 Pistachio
RX13 Meringue
RX14 Powder
RX15 Celadon
RX16 Custard
RX17 Marsh
RX18 Wisteria
RX19 Torte
RX20 Greige
RX21 Glaze
RX22 Skye Blue
RX23 Peppermint
RX24 Putty
RX25 Mesa

RINGER

66" Wide
100% Polyester

LUT100 Thyme
LUT102 Snowdrop
LUT104 Glacier
LUT106 Sandhurst
LUT108 Sea Salt
LUT110 Milky Way
LUT112 Nuetra
LUT114 Sierra
LUT116 Dusk

REPETITION

66" Wide
100% Recycled Polyester

RPT10 Reed
RPT11 Wicker
RPT12 Stainless
RPT13 Grey Green
RPT14 Kiwi
RPT15 Sisal
RPT16 Almond
RPT17 Cornflower
RPT18 Spa
RPT19 Willow
RPT20 Honeycomb
RPT21 tawny
RPT22 Steel
RPT23 Blue Grass
RPT24 Java
RPT25 Ash

TRAFFIC

66" Wide
100% Polyester

TF16 Metal
TF18 Sable
TF20 Gold Star
TF21 Horizon
TF25 Chalk Grey
TF26 Surf
TF28 Vintage
TF29 Mystic Purple
TF30 Blue Pearl
TF32 Grass
TF33 Water
TF34 Fire Brick
TF36 Blue Mica

SPIRO

66" Wide
100% Polyester

SR 4630 Dijon
SR1399 Cashmere
SR1717 Mist
SR2735 Cornflower
SR2746 Sky
SR4091 Milkshake
SR4116 Fawn
SR5753 Cranberry
SR5980 Hydrangea
SR8848 Spearmint